



HT-180
OPERATING
MANUAL



APEX DIGITAL, INC.
2919 E. Philadelphia Street
Ontario, CA 91761
909. 930. 1239 • TEL
909. 673. 0660 • FAX
www.apexdigitalinc.com

DVD
HOME THEATER SYSTEM

Safety Precautions



The lightning flash with an arrowhead symbol within an equilateral triangle is intended to alert the user to the presence of uninsulated "dangerous voltage" within the product's enclosure that may be of sufficient magnitude to constitute a risk of electric shock to persons.



The exclamation point within an equilateral triangle is intended to alert the user to the presence of important operating and maintenance (servicing) instructions in the literature accompanying the appliance.

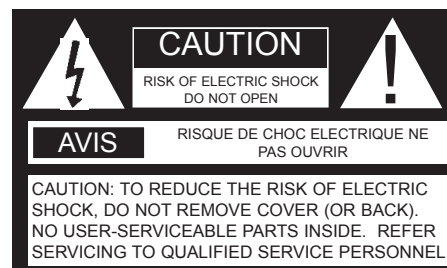

WARNING: DO NOT EXPOSE THIS APPLIANCE TO RAIN OR MOISTURE, DUE TO THE HIGH RISK OF FIRE OR ELECTRIC SHOCK, DO NOT OPEN THE CABINET ; DANGEROUS HIGH VOLTAGES ARE PRESENT INSIDE THE ENCLOSURE. ONLY QUALIFIED SERVICE PERSONNEL SHOULD ATTEMPT THIS.

CAUTION: TO PREVENT ELECTRIC SHOCK, MATCH WIDE BLADE OF PLUG TO WIDE SLOT, AND FULLY INSERT.

ATTENTION: POUR EVITER LES CHOCS ELECTRIQUE, INTRODUIRE LA LAME LA PLUS LARGE DE LA FICHE DANS LA BORNE CORRESPONDANTE DE LA PRISE ET POUSSER JUSQU' AU FOND.

CAUTION: This Digital Home Theater System employs a Laser System. To prevent direct exposure to the laser beam, do not try to open the enclosure. Visible laser radiation when open and interlocks defeated. Use of controls or adjustments or performance of procedures other than those specified herein may result in hazardous radiation exposure.
DO NOT STARE INTO BEAM.

To ensure proper use of this product, please read this owner's manual carefully and retain for future reference. Should the unit require maintenance, contact an authorized service location, or contact APEX Digital Inc. Only qualified service personnel should remove the cover.

FCC NOTICE: This equipment has been tested and found to comply with the limits for a Class B digital device. Pursuant to the Part 15 of FCC Rules. These limits are designed to provide reasonable protection against harmful interference in a residential installation.

This equipment generates, uses and can radiate radio frequency energy and, if not installed and used in accordance with the instructions, may cause harmful interference to radio communication. However, there is no guarantee that interference will not occur in a particular installation. If this equipment does cause harmful interference to radio or television reception, which can be determined by turning the equipment off and on, the user is encouraged to try to correct the interference by one or more of the following measures:

- Reorient or relocate the receiving antenna.
- Increase the separation between the equipment and receiver.
- Connect the equipment into an outlet on a circuit different from that to which the receiver is connected.
- Consult the dealer or an experienced radio/TV technician for help.

FCC Caution: To assure continued compliance, (example-use only shielded interface cables when connecting to computer or peripheral devices). Any changes or modifications not expressly approved by the party responsible for compliance could void the user's authority to operate this equipment.

WARNING: Changes or modifications made to this equipment, not expressly approved by APEX or parties authorized by APEX will void all the manufacture warranties.

THE REGION CODE FOR THE UNIT IS 1.

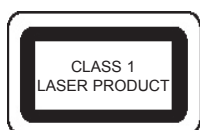

Since it is very usual for DVD movies to be released at different times in different regions of the world, all players have region codes and discs can have an optional region code. If you load a disc of a different region code to your player, you will see the region code notice on the screen. The disc will not play, and should be unloaded.

For Customer Use:

In spaces provided below, record the Model and Serial No. located on the rear panel of your unit.

Model No. _____ **Serial No.** _____

Retain this information for future reference.

Important Safety Instructions

CAUTION: Use of controls or adjustments or performance of procedures other than those specified herein may result in hazardous radiation exposure.

Please carefully study this manual and always keep it available. There are, however, some installation and operation precautions which you should be aware of.

1. Read Instructions - All the safety and operating instructions should be read before the product is operated.
2. Retain Instructions - The safety and operating instructions should be retained for future reference.
3. Heed Warnings - All warnings on the product and in the operating instructions should be adhered to.
4. Follow Instructions - All operating and use instructions should be followed.
5. Cleaning - Unplug this product from the wall outlet before cleaning. Do not use liquid cleaners or aerosol cleaners. Use a dry cloth for cleaning.
6. Attachments - Do not use attachments not recommended by the product manufacturer as they may cause hazards.
7. Water and Moisture - Do not use this product near water - for example the apparatus shall not be exposed to dripping splashing and that no objects fill with liquid such as vases, 'WARNING' To reduce the risk of fire or electric shock do not expose this apparatus to rain or moisture.
8. Accessories - Do not place this product on an unstable cart, stand, tripod, bracket, or table. The product may fall, causing serious injury to a child or adult, and serious damage to the product. Use only with a cart, stand, tripod, bracket, or table recommended by the manufacturer, or sold with the product. Any mounting of the product should follow the manufacturer's instructions, and should use a mounting accessory recommended by the manufacturer.



9. A product and cart combination should be moved with care. Quick stops, excessive force, and uneven surfaces may cause the product and cart combination to overturn.
10. Ventilation - Slots and openings in the cabinet are provided for ventilation and to ensure reliable operation of the product and to protect it from overheating, and these openings must not be blocked or covered. The openings should never be blocked by placing the product on a bed, sofa, rug, or other similar surface. This product should not be placed in a built-in installation such as a bookcase or rack unless proper ventilation is provided or the manufacturer's instructions have been adhered to.
11. Power Sources - This product should be operated only from the type of power source indicated on the marking label. If you are not sure of the type of power supply to your home, consult your product dealer or local power company. For products intended to operate from battery power, or other sources, refer to the operating instructions.
12. Grounding or Polarization - This product may be equipped with a polarized alternating-current line plug (a plug having one blade wider than the other). This plug will fit into the power outlet only one way. This is a safety feature. If you are unable to insert the plug fully into the outlet, try reversing the plug. If the plug should still fail to fit, contact your electrician to replace your obsolete outlet. Do not defeat the safety purpose of the polarized plug.

Important Safety Instructions

Alternate Warnings - This product is equipped with a three-wire grounding-type plug, a plug having a third (grounding) pin. This plug will only fit into a grounding-type power outlet. This is a safety feature. If you are unable to insert the plug into the outlet, contact your electrician to replace your obsolete outlet. Do not defeat the safety purpose of the grounding-type plug.

13. Power-Cord Protection - Power-supply cords should be routed so that they are not likely to be walked on or pinched by items placed upon or against them, paying particular attention to cords at plugs, convenience receptacles, and the point where they exit from the product.

14. Protective Attachment Plug - The product is equipped with an attachment plug having overload protection. This is a safety feature. See Instruction Manual for replacement or resetting of protective device. If replacement of the plug is required, be sure the service technician has used a replacement plug specified by the manufacturer that has the same overload protection as the original plug.

15. Outdoor Antenna Grounding - If an outside antenna or cable system is connected to the product, be sure the antenna or cable system is grounded so as to provide some protection against voltage surges and built-up static charges. Article 810 of the National Electrical Code, ANSI/NFPA 70, provides information with regard to proper grounding of the mast and supporting structure, grounding of the lead-in wire to an antenna discharge unit, size or grounding conductors, location of antenna-discharge unit, connection to grounding electrodes, and requirements for the grounding electrode.

16. Lightning - For added protection for this product during a lightning storm, or when it is left unattended and unused for long periods of time, unplug it from the wall outlet and disconnect the antenna or cable system. This will prevent damage to the product due to lightning and power-line surges.

17. Power Lines - An outside antenna system should not be located in the vicinity of overhead power lines or other electric light or power circuits, or where it can fall into such power lines or circuits. When installing an outside antenna system, extreme care should be taken to keep from touching such power lines or circuits as contact with them might be fatal.

18. Overloading - Do not overload wall outlets, extension cords, or integral convenience receptacles as this can result in a risk of fire or electric shock.

19. Object and Liquid Entry - Never push objects of any kind into this product through openings as they may touch dangerous voltage points or short-out parts that could result in a fire or electric shock. Never spill liquid of any kind on the product.

20. Servicing - Do not attempt to service this product yourself as opening or removing covers may expose you to dangerous voltage or other hazards. Refer all servicing to qualified service personnel.

21. Damage Requiring Service - Unplug this product from the wall outlet and refer servicing to qualified service personnel under the following conditions:

- a. When the power-supply cord or plug is damaged.
- b. If liquid has been spilled, or objects have fallen into the product.
- c. If the product has been exposed to rain or water.

Important Safety Instructions

- d. If the product does not operate normally by following the operating instructions. Adjust only those controls that are covered by the operating instructions as an improper adjustment of other controls may result in damage and will often require extensive work by a qualified technician to restore the product to its normal operation.
 - e. If the product has been dropped or damaged in any way, and
 - f. When the product exhibits a distinct change in performance - this indicates a need for service.
- 22.Replacement Parts - When replacement parts are required, be sure the service technician has used replacement parts specified by the manufacturer or have the same as the original part. Unauthorized substitutions may result in fire, electric shock, or other hazards.
- 23.Safety Check - Upon completion of any service or repairs to this product, ask the service technician to perform safety checks to determine that the product is in proper operating condition.
- 24.Wall or Ceiling Mounting - The product should be mounted to a wall or ceiling only as recommended by the manufacturer.
25. Heat - The product should be situated away from heat sources such as radiators, heat registers, stoves or other products (including amplifiers) that produce heat.

Introduction

Thank you for purchasing our APEX DIGITAL DVD Home Theater System with AM/FM Tuner. With it, you will be able to enjoy full length DVD movies with true cinema picture quality, and stereo multichannel sound. What's more, Parental Control lets you decide which discs your children will be able to see. Your Player supports audio CD and the new MP3 format.



You will find your player remarkably easy to use, by way of the On-Screen Display (setup menu), player display and wireless remote control. The HT-180 has over-heat protection. When the HT-180 is used in long term and high power with poor ventilation, the unit enables the protection automatically due to over-heat.

UNPACKING

When shipping the Home Theater System, the original shipping carton and packing comes in handy. For maximum protection, repack the unit as it was originally packed at the factory.

First check and identify the contents of your HT-180 package, as listed below:

- DVD Home Theater Tuner/Amplifier
- Remote control handset
- RCA cable (yellow, red, and white)
- Owner's manual
- Size AAA batteries (2)
- AM loop antenna (1)
- FM wire antenna (1)
- Speakers (5)
- Subwoofer (1)
- Speaker cords (6)

If any item should be damaged or missing, please inform your dealer without delay.

Keep the packaging materials, you may need them to transport your player in the future.

WHERE TO LOCATE YOUR DVD

- Place the unit on a firm, flat surface.
- When you place the HT-180 near other units, the playback picture may become poor and/or distorted. In this situation, move the HT-180 further away from them.
- Keep away from direct sunlight & domestic heating equipment.
- If placed in a cabinet, please allow at least 2.5 cm (1 inch) of free space all around the player for proper ventilation.

TO OBTAIN A CLEAR PICTURE

The HT-180 is a high technology, precision device. If the optical pick-up lens and disc drive parts are dirty or worn down, the picture quality may become poor. To obtain a clear picture, we recommend regular inspection and maintenance (cleaning or parts replacement) every 1,000 hours of use depending on the operating environment. For details, contact your nearest dealer.

Notes:

The OSD and illustration in this manual may be somewhat different from the actual situation. Please take the unit as the standard.

Notes on Discs

HOW TO HANDLE, CLEAN, AND STORE DISCS.

HANDLING DISCS

- Do not touch the playback side of the disc.
- Do not attach paper or tape to discs.



CLEANING DISCS

- Fingerprints and dust on the disc cause picture and sound deterioration. Wipe the disc from the center outward with a soft cloth. Always keep the disc clean.
- If you cannot wipe off the dust with a soft cloth, wipe the disc lightly with a slightly moistened soft cloth and finish with a dry cloth.
- Do not use any type of solvent such as a thinner, benzene, commercially available cleaners or anti-static spray for vinyl LP's. It may damage the disc.

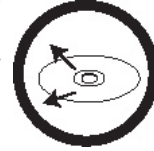

STORING DISCS

- Do not store discs in places subject to direct sunlight or near heat sources.
- Do not store discs in places subject to moisture and dust such as a bathroom or near a humidifier.
- Store discs vertically in a case. Stacking or placing objects on discs outside of their case may cause warping.

PLAYABLE DISCS

This HT-180 can play back the following discs.

	Disc Mark	Contains	Disc Size	Maximum playback time
DVD video disc		Audio + Video (moving pictures)	12 cm	Approx. 4 hours (single sided disc)
				Approx. 8 hours (double sided disc)
Audio CD		Audio	12 cm	Approx. 74 minutes
			8 cm (CD single)	Approx. 20 minutes
MP3 CD		Audio	12 cm	Approx. 600+ minutes
Kodak Picture CD		Spec.	12 cm	

NOTES ON REGIONAL NUMBERS

DVDs are divided into separate regions. The United States and Canada are designated as region 1 DVD. Your unit plays region 1 DVDs only.

SELECTING THE TYPE OF DISC COMPATIBLE WITH YOUR TV

Both DVD discs have material recorded in either PAL or NTSC format. Refer to the table below to select the disc type compatible with your TV.

The type of Connected TV	Disc	TV Monitor
Multi-system	PAL	Played in the PAL system.
	NTSC	Played in the NTSC system.
NTSC	PAL	No clear images are shown on the screen.
	NTSC	Played in the NTSC system.
PAL	PAL	Played in the PAL system.
	NTSC	No clear images are shown on the screen.

Manufactured under license from Dolby Laboratories. "Dolby" and the double-D symbol are trademarks of Dolby Laboratories. Confidential Unpublished works. ©1992-1997 Dolby Laboratories, Inc. All rights reserved.

"DTS" and "DTS Digital Out" are trademarks of Digital Theater Systems, Inc.

It is forbidden by law to copy, broadcast, play in public, and rent copyrighted material without permission. DVDs are copy protected and any recorded copies made will be distorted.

This product incorporates copyright protection technology that is protected by method claims of certain U.S. patents and other intellectual property rights owners. Use of this copyright protection technology must be authorized by Macrovision Corporation, and is intended for home and other limited viewing uses only unless otherwise authorized by Macrovision Corp. Reverse engineering or disassembly is prohibited.

Table of Contents

Safety Precautions.....	1	Selecting the Camera Angle/	
Important Safety Instructions.....	2-4	Selecting a Language	26
Introduction.....	5	Playing in a Favorite Order.....	27
Notes on Discs.....	6	Selecting Subtitles	28
Index of Parts and Controls.....	8-11	Karaoke.....	29
Connecting to a TV.....	12	MP3 Operation.....	30
Connecting to a TV using an RF Modulator.....	13-14	Working with Your JPEG Files	31-32
Speaker System Hookup.....	15	Playing Back Your Kodak Picture CD. .	33
Antenna Hookups & HT-180/AV Amplifier Connection for AV Input.....	16	Using the On-Screen Display	34
Playing Back a Disc.....	17-21	Setting the Parental Lock.....	35
Locating a Specific Title, Chapter or Track.....	22-23	Customizing the Function Settings.....	36-38
Playing Repeatedly	24	AFF Function.....	39
Zooming a Picture	25	Memo On Output Sounds.....	40
		Specifications.....	41
		Trouble Shooting Guide.....	42
		Limited Warranty.....	43

Index of Parts and Controls

FRONT PANEL

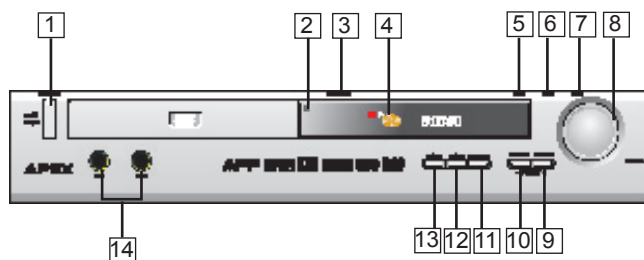

- 1 POWER ON/OFF
- 2 INFRARED SENSOR
- 3 OPEN/CLOSE
- 4 STANDBY/ON INDICATOR
- 5 ► PLAY
- 6 ■ STOP
- 7 || PAUSE
- 8 VOLUME KNOB
- 9 MULTI-PURPOSE BUTTON
 - a) NEXT ►►: page down or skip to next track
 - b) PRESET +: scan forward all the stations preset
- 10 MULTI-PURPOSE BUTTON
 - a) ◀◀PREV: page up or skip to previous track
 - b) PRESET -: scan reverse all the stations preset
- 11 FUNCTION: switches among DVD, Tuner and Analog in
- 12 FM/AM: switch in FM and AM
- 13 MODE
- 14 MIC JACKS

FRONT PANEL DISPLAY

When playing back a DVD

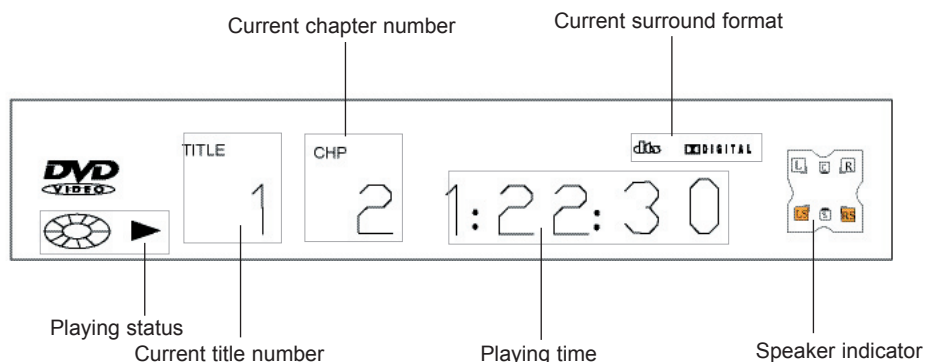

When playing back a Audio CD

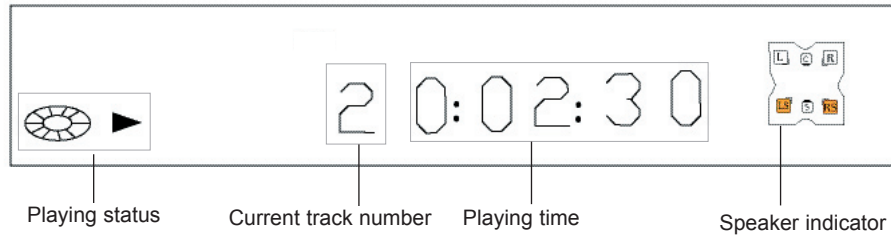

When listening to the radio

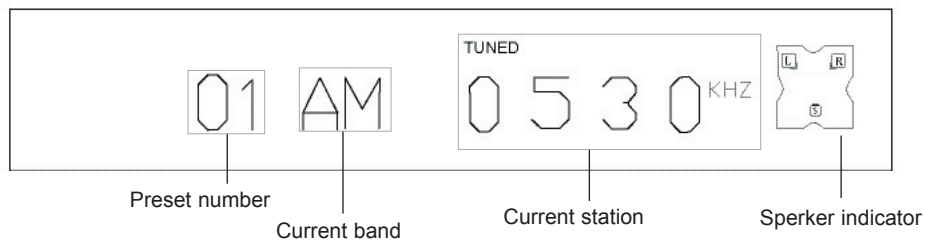

REAR PANEL

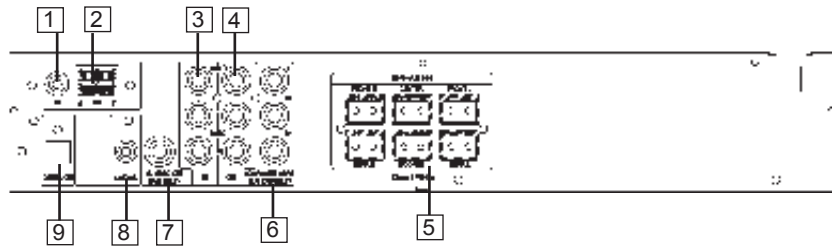

- | | | |
|--|---|--|
| <p>1 FM 75 ohms WIRE ANTENNA</p> <p>2 AM LOOP ANTENNA</p> <p>3 AV INPUT
COMPOSITE VIDEO,AUDIO L,AUDIO R</p> <p>4 AV MONITOR OUTPUT
COMPOSITE VIDEO,AUDIO L,AUDIO R</p> | <p>5 (DOLBY 5.1 CHANNEL) SPEAKER
TERMINAL
FRONT R(+/-) CENTER(+/-) FRONT L (+/-)
REAR R (+/-) WOOFER(+/-)
REAR L(+/-)</p> <p>6 COMPONENT VIDEO OUTPUT</p> | <p>7 S-VIDEO OUTPUT</p> <p>8 DIGITAL COAXIAL OUTPUT
(DIGITAL AUDIO SIGNAL OUTPUT)</p> <p>9 DIGITAL OPTICAL OUTPUT
(DIGITAL AUDIO SIGNAL OUTPUT)</p> |
|--|---|--|

Notes:
The terminal printed with "DVD ONLY" on the rear panel indicates that this terminal can only function when the internal signal is output from the DVD disc.

The items mentioned in this manual, displayed on OSD or VFD, printed on rear panel are listed below in the left column corresponding to those listed in the right:

- | | | |
|------------------------|---|---------------------|
| L/FL/Front L | → | Front left channel |
| R/FR/Front R | → | Front right channel |
| SL/LFET SUR/LS/REAR L | → | Rear left channel |
| SR/RIGHT SUR/RS/REAR R | → | Rear right channel |
| C | → | Center |
| W/SW | → | Woofer or Subwoofer |

Index of Parts and Controls

Continued

THE INSTRUCTIONS BELOW DESCRIBE THE FUNCTIONS ON THE REMOTE CONTROL.

- 1.DISPLAY
- 2.FUNCTION
- 3.POWER
- 4.A-B REPEAT
- 5.GOTO
- 6.REPEAT
- 7.NUMBER
- 8.SUBTITLE
- 9.AUDIO
- 10.ANGLE
- 11.DIRECTION
- 12.ECHO +
- 13.ECHO -
- 14.SETUP
- 15.MULTI-PURPOSE
(SKIP FORWARD OR PRESET+)
- 16.MULTI-PURPOSE
(SKIP BACKWARD OR PRESET-)
- 17.FM/AM
- 18.PLAY/ PAUSE
- 19.STOP
- 20.MULTI-FUNCTION
(FAST REVERSE OR TUNING-)
- 21.MULTI-FUNCTION
(FAST FORWARD OR TUNING+)
- 22.MIC VOLUME +
- 23.MIC VOLUME -
- 24.ENTER
- 25.MODE
- 26.VOLUME+/-
- 27.MUTE
- 28.PAL/NTSC
- 29.RESUME

NOTES

- Please turn on the master power switch on the HT-180. Power button on this remote control unit is for standby power only.
- MUTE Cut off sound momentarily. Press again to reinstate sound.
- VOLUME+/- controls the audio output from the HT-180. (VOLUME control is only available in audio analog output status.)
- When “” displayed on TV,function is not operational on the disc.

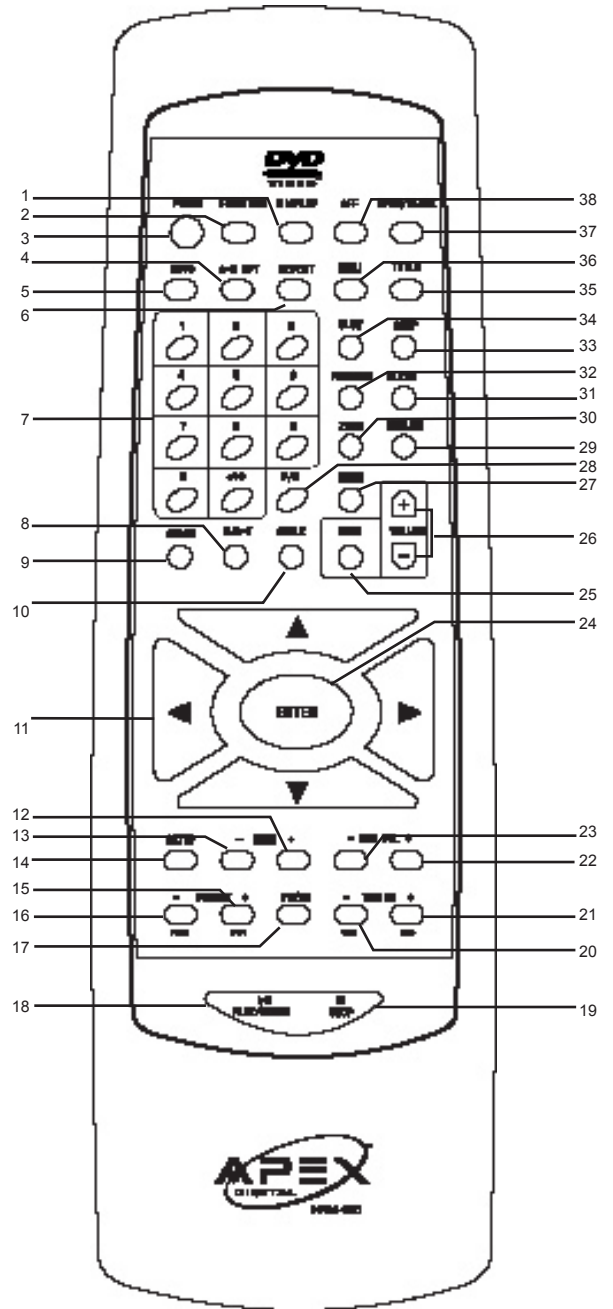

- 30.ZOOM
- 31.CLEAR
- 32.PROGRAM
- 33.STEP
- 34.SLOW
- 35.TITLE
36. MENU
- 37.OPEN/CLOSE
38. AFF(APEX Full-screen function)

PREPARING THE REMOTE CONTROL

To operate the HT-180, you must first place the batteries in the remote control.

1

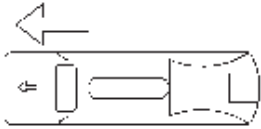

Open the cover.

2

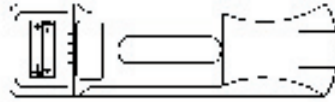

Insert batteries (AAA size).
Make sure to match the + and - on the batteries to the marks inside the battery compartment.

3

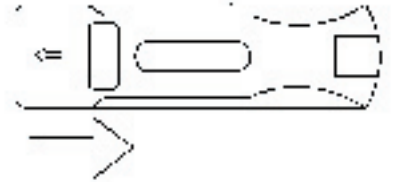

Close the cover.

OPERATING WITH THE REMOTE CONTROL

Operating HT-180 with the remote control.



The remote control must point at the remote sensor, in order for the HT-180 to function correctly.

Distance: Maximum of 7m from the front of the remote sensor.

Angle: Approximately 30° from each direction.

*Please do not place the remote sensor towards any light source such as direct sunlight or illumination. If you do so, the HT-180 will malfunction.

NOTICE

FOLLOW INSTRUCTIONS BELOW BECAUSE INCORRECT USE OF BATTERIES MIGHT CAUSE THEM TO LEAK OR CORRODE.

- Do not place the batteries in the wrong direction.
- It is dangerous to charge/heat/open or short-circuit the batteries.
- Do not leave dead batteries or mix old/new batteries in the remote control.
- When not using the remote control for a long duration of time, remove the batteries.
- If leakage from the battery occurs, wipe the battery liquid from the battery compartment, then replace the batteries.

Connecting to a TV

SETTING UP YOUR PLAYER

Step1: Connect the RCA cable (red & white) from audio outputs of the HT-180 to the TV Audio Inputs.
Step2: Connect the RCA cable (yellow) from the video output on the back of your player to the TV Video Input. (For TVs that support S-video Input please follow the diagram to the right.)

GOOD

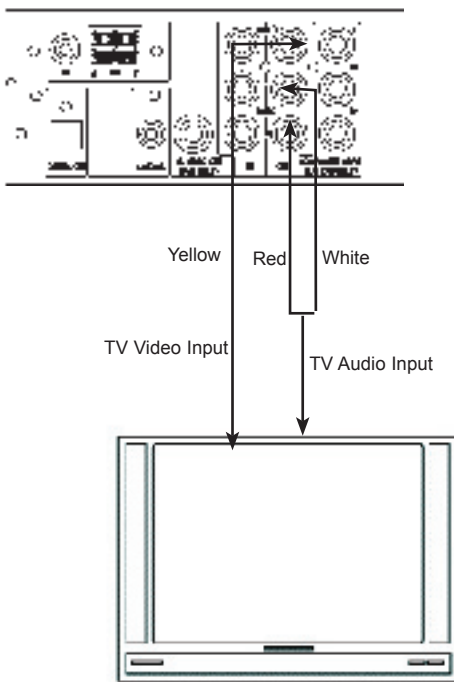

BETTER

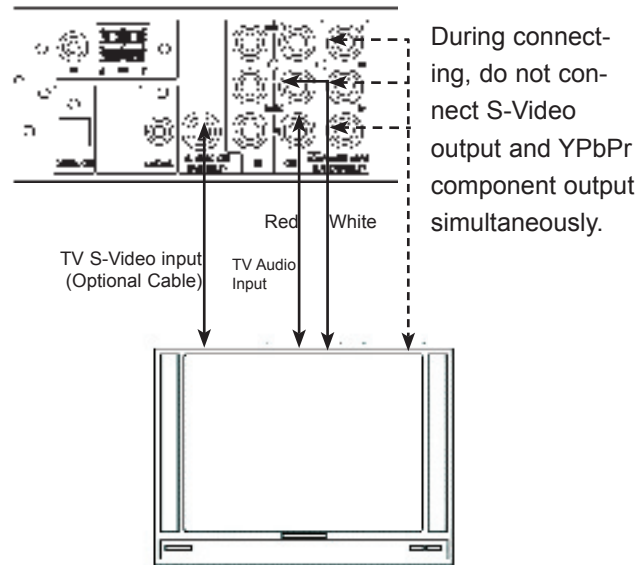

Connect the HT-180 with an optional S-Video cable, if the TV has an S-Video input. Do not connect the yellow video cable if using the S-Video cable.

NOTICE

- Turn off the power and unplug both units before setting up any connections.
- If your TV only has a cable antenna connection and no video inputs to connect your TV to the HT-180, you will need to purchase an RF adapter from your dealer. See store for details.
- Please refer to the user manual of TV.
- All the terminals indicated on the rear panel of TV is only for reference.
- Connect the unit with an optional S-Video cable if the TV has an S-Video input. The quality of the picture is better than that produced by using composite video cable.
- Connect the unit with video component output if the TV has Y, Pb and Pr input, you may obtain the optimum picture quality.
- If you connect the unit to a TV based on the figures above, please set "Downmix" to "Stereo" or "LT/RT".

Connecting to a TV using an RF Modulator

Many older televisions do not have the newer Component-Video, Composite-Video, or S-Video connections that optimize DVD technology. While it would be advised to purchase a newer television in order to take full advantage of the digital quality of DVD's, it is possible to connect an older television to a Home Theater System . This connection requires a device called an RF modulator.

First, it is necessary to ascertain whether or not your TV needs an RF Modulator. Look at the back of your TV. If you see three input connectors lined up in a row, in the colors of yellow, red, and white, then you will not need an RF modulator. If you see the connectors labeled "S-Video" or "Component Video", then you will not need an RF Modulator. If you do not have either of these connectors, then you will need to purchase an RF Modulator from the store where you purchased your Apex Digital Home Theater System or other home electronics retailers.

Older televisions use a coaxial connection, which combines all of the video signal from an exterior source into a single line. This line is then translated by your TV into the picture you see. The RF modulator combines the output signals from the Home Theater System , or any other device, into the coaxial connection for use by your television.

Below are written and pictorial instructions on the proper way to connect an RF modulator to your Apex Home Theater System and your TV.

Connection 1

Connecting the TV to the unit through the VCR

Figure 1

Note: All VCRs will distort the picture of a Home Theater System . This is NOT a malfunction of the Home Theater System or VCR. All DVD manufacturers are required to install macrovision copyright circuitry to prevent copying via VCR. This is what causes the distortion.

1) Connect the three-terminal composite video cable to the back of your Apex Home Theater System . This cable has three prongs, one each in yellow, red, and white. The yellow prong will go into the jack labeled "Video Out"; the white prong will go into the jack labeled "AUDIO L OUT"; the red prong will go into the jack labeled "AUDIO R OUT".

2) Connect the opposite end of the composite video cable into the back of the RF modulator. Make sure to match up the colors correctly.

3) Connect a coaxial cable from the "Antenna Out" jack on the back of your VCR to the "Antenna" jack on the RF modulator. The coaxial cable is the one-wire, metal-ended type that you screw onto the VCR.

4) Connect a coaxial cable from the "To TV" jack on the RF modulator to the jack on the back of your TV.

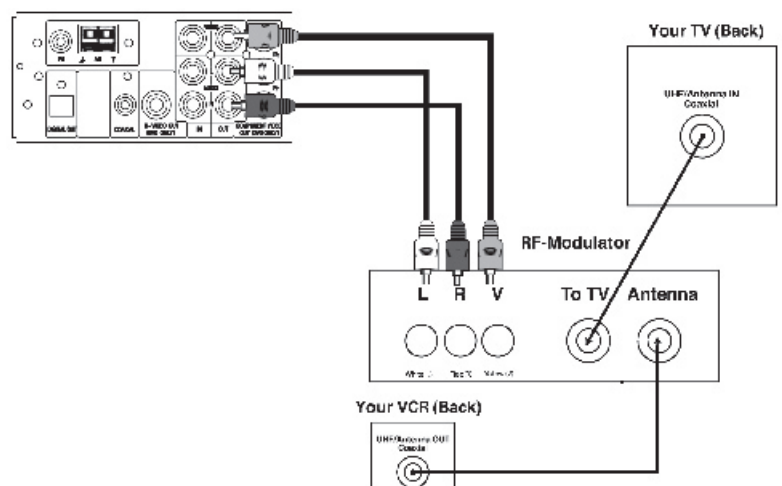

5) Make sure your TV is set to the appropriate channel before using your Home Theater System . In most cases, this is channel 3 or 4.

Connection 2

Connecting the TV, unit, RF Modulator and Cable or Satellite Box

- 1) Connect the three-terminal composite video cable to the back of your Apex Home Theater System . This cable has three prongs, one each in yellow, red, and white. The yellow prong will go into the jack labeled "Video Out"; the white prong will go into the jack labeled "AUDIO L OUT"; the red prong will go into the jack labeled "AUDIO R OUT".
- 2) Connect the opposite end of the composite video cable into the back of the RF modulator. Make sure to match up the colors correctly.
- 3) Connect a coaxial cable from the "Antenna Out" jack on the back of your Satellite receiver to the "Antenna" jack on the RF modulator. The coaxial cable is the one-wire, metal-ended type that you screw onto the Cable or Satellite Box.

Figure 2

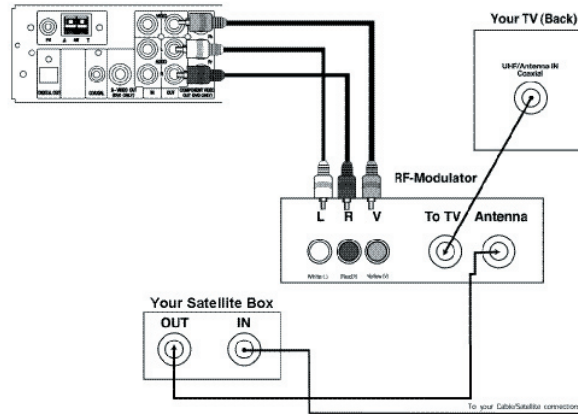

- 4) Connect a coaxial cable from the "To TV" jack on the RF modulator to the jack on the back of your TV.
- 5) Make sure your TV is set to the appropriate channel before using your Home Theater System . In most cases, this is channel 3 or 4.

Connection 3

Connecting the TV , unit, VCR, RF Modulator and Cable or Satellite Box

- 1) Connect the three-terminal composite video cable to the back of your Apex Home Theater System . This cable has three prongs, one each in yellow, red, and white. The yellow prong will go into the jack labeled "Video Out"; the white prong will go into the jack labeled "AUDIO L OUT"; the red prong will go into the jack labeled "AUDIO R OUT".
- 2) Connect the opposite end of the composite video cable into the back of the RF modulator. Make sure to match up the colors correctly.
- 3) Connect a coaxial cable from the "OUT" jack on the back of your satellite receiver to the "IN" jack on the back of your VCR. The coaxial cable is the one-wire, metal-ended type that you screw onto the VCR.
- 4) Connect a coaxial cable from the "OUT" jack on the back of your VCR to the "Antenna" jack on the RF modulator.

Figure 3

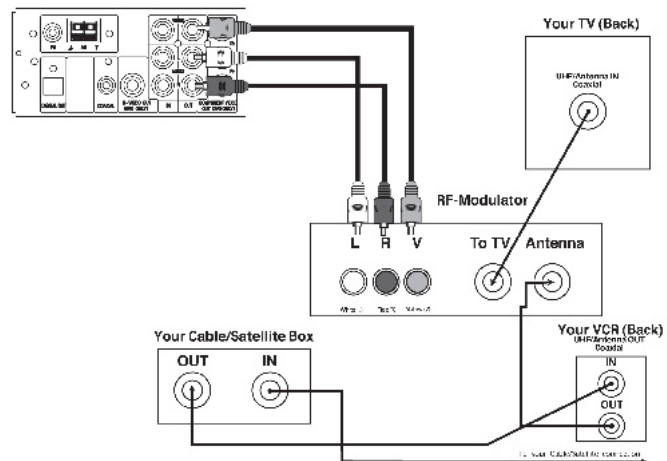

- 5) Connect a coaxial cable from the "To TV" jack on the RF modulator to the jack on the back of your TV. In most cases, this is channel 3 or 4. Also make sure that the VCR is set to the appropriate channel, as well.
- 6) Make sure your TV is set to the appropriate channel before using your Home Theater System . In most cases, this is channel 3 or 4. This selector is usually on the back of your VCR. Consult your VCR manual for further information.

Speaker System Hookup

Connect the supplied speaker system using the supplied speaker cords by matching the polarities and colours of the terminals.

NOTE: Please refer to “Setup Menu” for parameter setup.

HOW TO CONNECT?

Your speaker connection is made easy by matching the color coded speaker terminal to the color coded terminals on the back of the HT-180.

- Connect front speaker with SPEAKER FRONT R and SPEAKER FRONT L.
- Connect rear speaker with SPEAKER REAR R and SPEAKER REAR L.
- Connect center speaker to SPEAKER CENTER.
- Connect subwoofer to SPEAKER WOOFER.

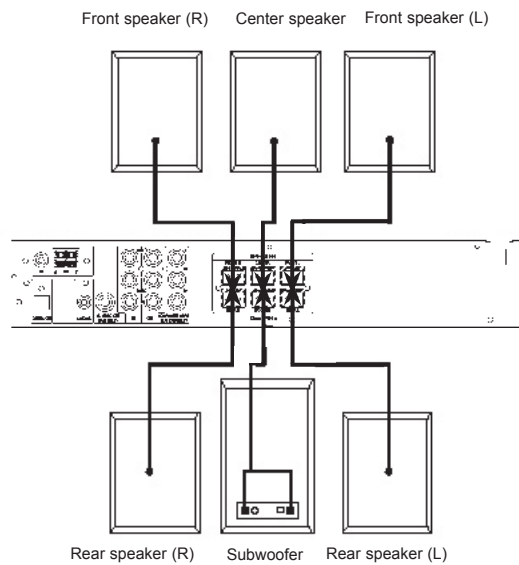

SPECIFYING THE SPEAKER PARAMETERS

To obtain the best possible surround sound, first specify the distance of the speakers from your listening position, then set the balance and level. Use the test tone to adjust the speaker volumes to the same level. When you test the speakers with “TEST TONE”, subwoofer will not respond.

You may adjust the speaker parameters using Speaker Setup in the setup menu.

NOTES:

- Depending on the settings of other speakers, the subwoofer may output excessive sound.
- If the distances of the speakers are not equal, adjust the speaker with shortest distance to the listener.
- According to the speakers, you may set delay value of the speaker via the “Speaker Setup”.

Notice for Speakers:

1. Short-circuiting of the speakers may damage the system. To prevent this, be sure to follow these precautions when connecting the speakers. Make sure the bare wire of each speaker cord does not touch another speaker terminal or the bare wire of another speaker cord.
 - Do not connect audio outputs of the same speaker or those between the speakers, that may cause short circuit.
 - The examples of bad conditions of the speaker cord: Exposed end speaker cord is touching another speaker terminal; exposed end cords are touching each other due to sloppy removal of insulation.
 - After connecting all the equipments, speakers and AC power cord (mains lead), output a test tone to check that all the speakers are connected correctly.
2. Please make sure the connections between speakers and the equipment are correct.
3. If you use front speakers with maximum input rating, adjust the volume carefully to avoid excessive output on the speakers.

Antenna Hookups & HT-180/AV Amplifier Connection for AV Input

Antenna Hookups

Connect the supplied AM/FM antennas for listening to the radio

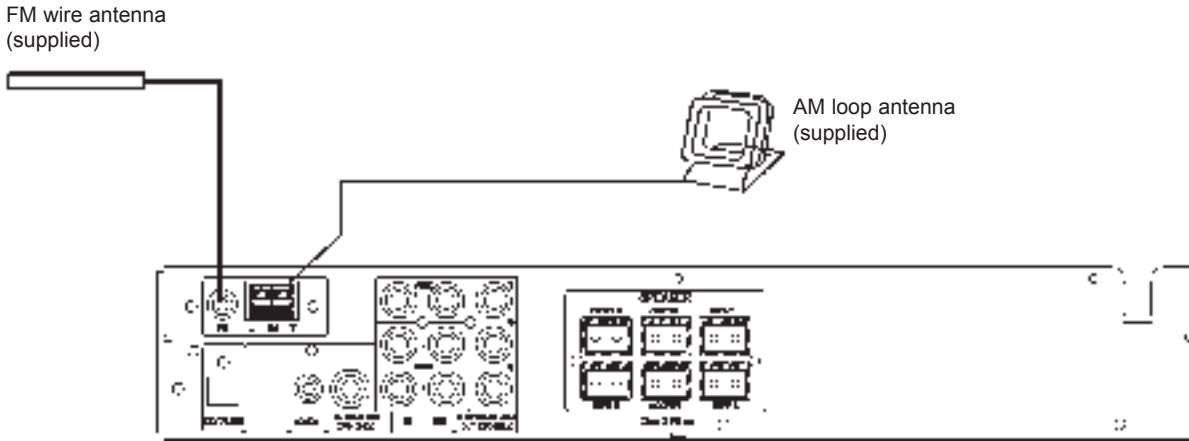

Press the "FUNCTION" until "FM" appears on the display of the unit to access the radio. Press FM/AM to switch the band.

HT-180/AV Amplifier Connection for AV Input

The HT-180 allows you to connect other audio/video equipment to playback through the speaker system.

For AV:

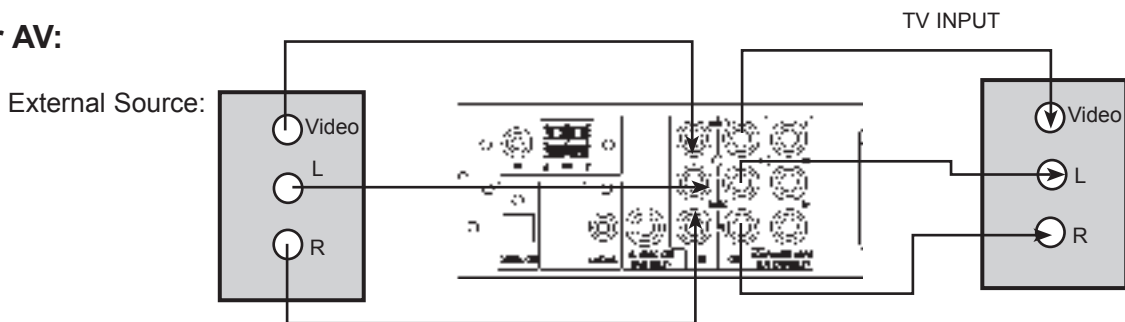

Press the "FUNCTION" until "ANALOG IN" appears on the display of the unit to access the Audio/Video input from external source .

Playing Back a Disc

HOW TO PLAYBACK A DISC.

Basic Playback

Turn on the TV and choose the video input source that is connected to the HT-180.

How to enjoy the sound from the audio system

- If you don't have the necessary equipment to enjoy Dolby Digital surround sound, set "Audio out" to "Analog" from the Audio Setup menu.

1. Press the POWER button on the front panel.

Please note that remote control power button is only active when front panel power button is turned on.

The POWER indicator lights up in red, the HT-180 turns on.

2. Press the OPEN/CLOSE button.



This will open the disc tray.

3. Place the disc on the disc tray.

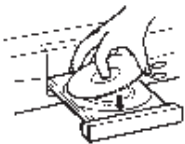

Be sure the playback side is faced down. Then press OPEN/CLOSE button to close the disc tray. The unit starts to read the disc and some information will be displayed on the screen. Playback will start automatically.

Notice

- A disc may be damaged if it is not correctly placed on the guides in the disc tray, this may also cause the HT-180 to malfunction.
- Do not touch the playback side of the disc. For the single-side disc, the side printed with instructions can not be played back.
- Do not force or place anything other than DVD video disc, audio CDs, or MP3 CD on the disc tray.

4. Program Menu

After reading the disc, the menu screen will appear and you may select different chapters by pressing DIRECTION or NUMBER buttons, then press ENTER button.

- For the DVD discs, you can highlight the items you want with  buttons.

NOTICE

- Moving the HT-180 during DVD playback may cause damage to the disc as well as the player.
- To open and close the disc tray, you may only use the OPEN/CLOSE button.

Playing Back a Disc

5. To stop playback

- For DVD discs:press STOP button for the first time, the unit return to logo. Press the STOP button twice to stop playback completely.
- On some special discs, STOP may not function.

6. Replace the disc

Press the OPEN/CLOSE button to open the disc tray, then replace the disc.

Notice:

- After replacing the disc, press the OPEN/CLOSE button to ensure the disc tray close completely.
- Press OPEN/CLOSE button during playback , the unit stops and the disc tray opens.

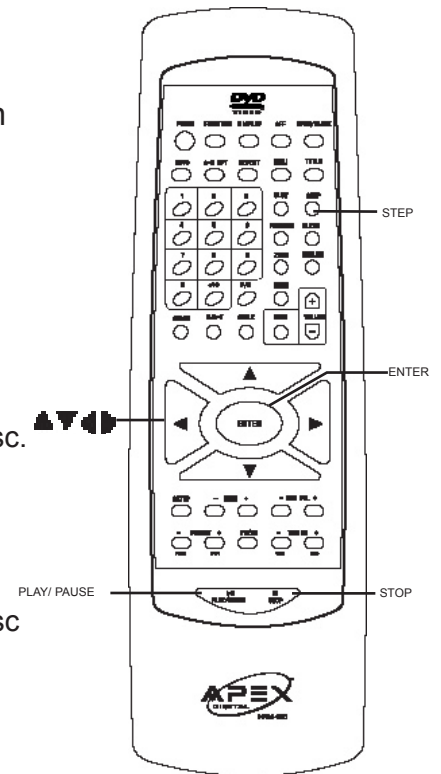

7. Standby

Press the POWER button on the remote control, the unit will enter standby status.

The POWER indicator will keep on on the display of the unit.

NOTICE

- Do not push the disc tray by hand or place anything other than the discs on the disc tray, otherwise it may cause malfunction.
- Moving the unit during playback may cause damage to the disc as well as the system.
- After replacing the disc, press the OPEN/CLOSE button to ensure the disc tray close completely.



Playing Back a Disc

PLAYING AT 2X, 4X, 6X OR 8X THE NORMAL SPEED

You can play back a disc at 2x, 4x, 6x or 8x the normal speed.

Press the  or  button during playback.

The playback speed becomes 2x the normal speed.

The playback speed changes, each time you press the  or  button.

Fast reverse 

Fast forward 

TV SCREEN

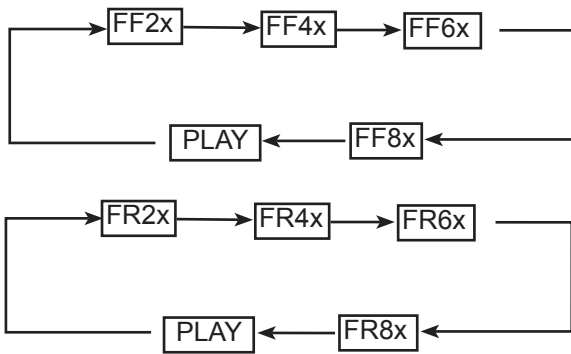

TO RESUME NORMAL PLAYBACK.
Press PLAY/PAUSE.

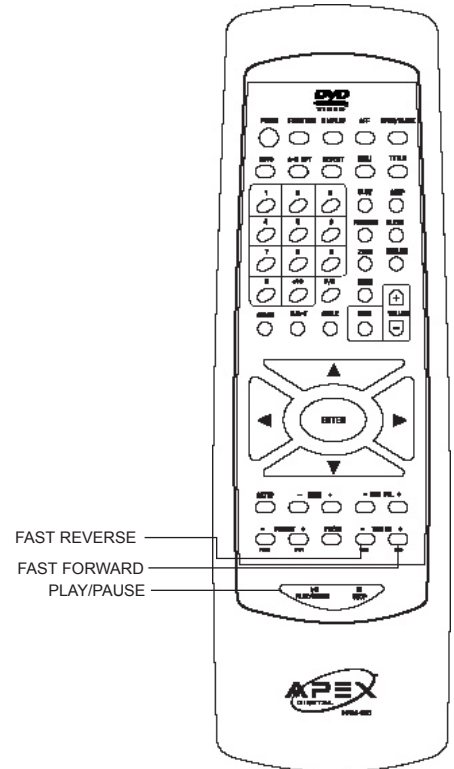

- Audio CD
The reverse or forward playback alternates between 1x, 2x, 3x, 4x speed.

NOTICE

- The HT-180 may not playback sound and subtitles during scan reverse and forward of DVDs.
- The speeds may vary slightly from disc to disc. 2x, 4x, 6x and 8x speeds are only approximate speeds.
- Some MP3 CDs, CDs and DVDs may not function.

PLAYING IN SLOW-MOTION

A disc can also be played back in slow-motion.

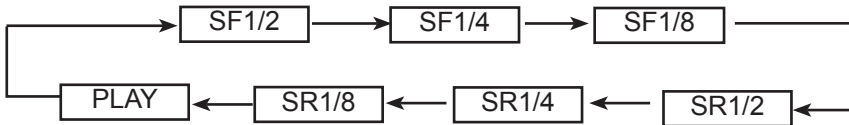

Press the SLOW button during playback
 The playback speed becomes 1/2, 1/4 or 1/8 each time you press the SLOW button.

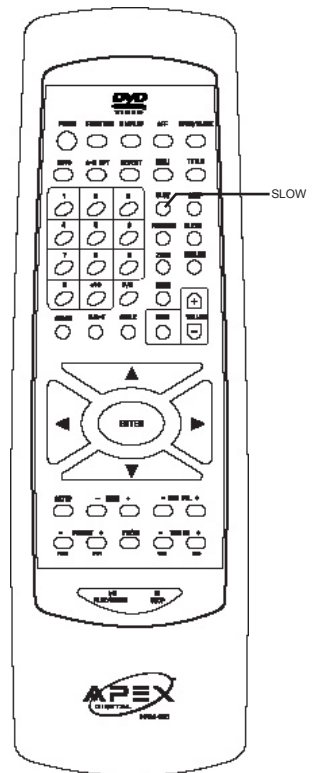
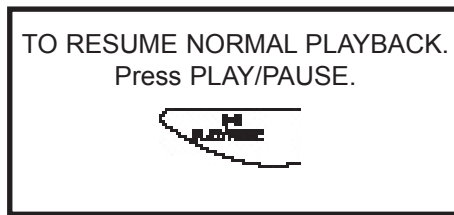

NOTICE

- During the slow-motion playback, the sound is muted.
- Some MP3 CD/CDDA discs may not function.

RESUMING PLAYBACK FROM THE SAME LOCATION

Stop playback and resume later from the same location on the disc.

RESUME



1. Press the RESUME button during stop
 The HT-180 will start playback from the location where you stopped.
2. For DVD disc press the STOP button, then press PLAY/PAUSE.
 The HT-180 will resume the playback from the location where you stopped.

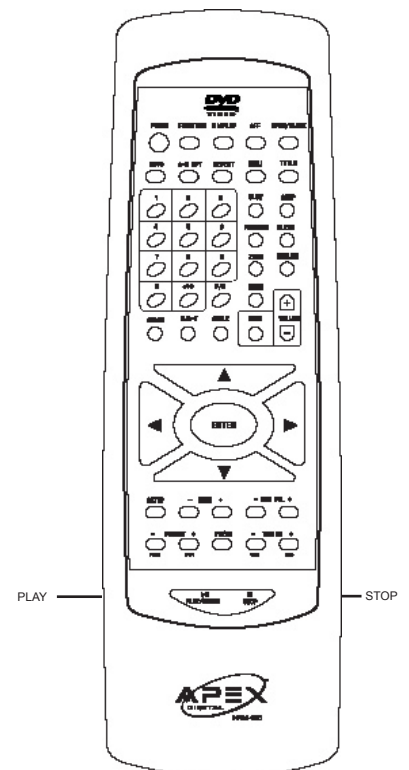



NOTICE

- The following actions will cancel the RESUME function:
 - Unplugging the HT-180 after you stop playback.
 - Ejecting the disc.
 - When in Standby, switch to the Tuner or in external Analog In mode.
- On occasion depending on the disc, you may experience a difference of location where playback resumes.

SKIP SELECTION

You can select the certain chapter very quickly.

Press the SKIP   buttons repeatedly, you can scan forward/backward the programs very quickly.

Notice:

The displays may vary depending on the disc.

During playing back the directory, when you press the SKIP   buttons, directory item may be selected.

PLAYBACK FRAME BY FRAME

You can playback the disc frame by frame. (CD, MP3 excluded)

1. Press the STEP button during playback

The picture will be still and the sound is mute. Once you press the button, the picture will advance one frame.

2. To resume normal playback.

Press the PLAY/PAUSE button.

VOLUME CONTROL

1. Press the MODE button, the TV screen will display as follows:

LEFT → CENTER → RIGHT → RIGHT SUR → LEFT SUR → SUBWOOFER → TREBLE → BASS → VOL



2. Press the VOLUME +/- button to adjust volume of the channels.

Volume up: press the VOLUME+ button; volume down: press the VOLUME- button.

Max.40 Min.0

Once you press the buttons, the volume will increase or decrease by one unit.

Locating a Specific Title, Chapter or Track

THE DVDs ARE NORMALLY DIVIDED INTO TITLES. THE TITLES ARE SUB-DIVIDED INTO CHAPTERS. MOREOVER, AUDIO CD AND MP3 CD ARE DIVIDED INTO TRACKS. YOU CAN CONVENIENTLY LOCATE ANY SPECIFIC TITLE, CHAPTER, OR TRACK WITH THIS DVD VIDEO PLAYER.

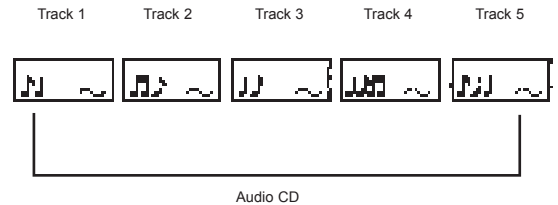
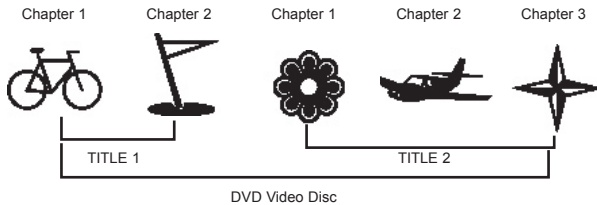

1. Press the TITLE button

On the TV screen, the title menu will appear.

2. Press the button to select the title you want

You can also directly locate a specific title by pressing its assigned number with the number buttons.

3. Press the PLAY/PAUSE button

This will cause the HT-180 to start playback from chapter 1 of the title selected.

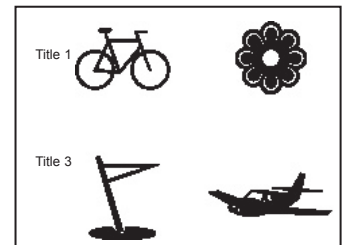
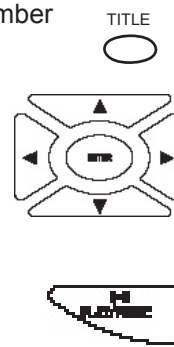

Example of a title menu.

NOTICE

- Some discs will not respond to this function.
- If different instructions appear on the TV screen, follow them. The instructions above are describing the basic procedure. Procedures may vary depending on the contents of the DVD video disc.

Locating a Specific Title, Chapter or Track

LOCATING A TITLE OR TRACK

For DVD disc:

1. By pressing the **GOTO** button during playback, the screen will display your current location on the disc. In this mode you have the ability to change chapters by pressing **NUMBER** buttons.

TITLE 01/03 CHAPTER **001**/010

A. You can shift the highlights between TITLE and CHAPTER by pressing  buttons.

B. Input the TITLE and CHAPTER number that you want, then press **ENTER**.

2. Pressing **GOTO** button twice will display hours, minutes and seconds field. In this field you can enter the specific hours, minutes and seconds you would like to go to.

TITLE 01/03 TIME --:--:--

Input the 2-digit number by pressing **NUMBER** buttons, then press **ENTER**.

For Audio CD disc:

Press **GOTO** button, TV displays:

GO TO--:--

Input the time by pressing **NUMBER** buttons.

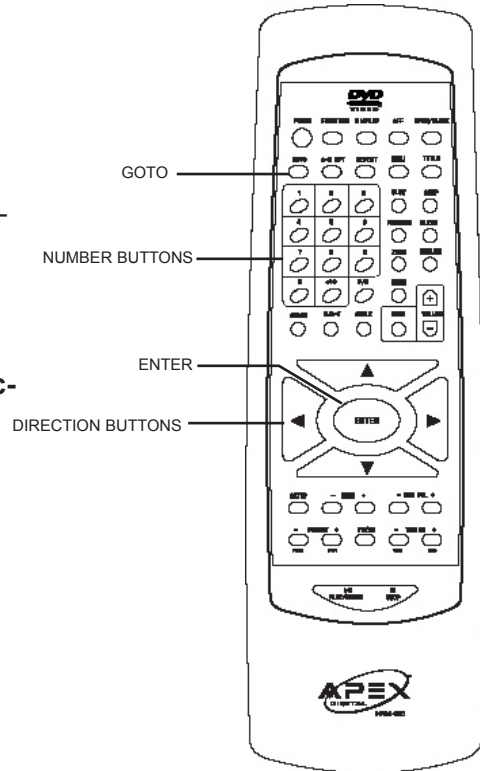

NOTICE

- Displayed items are based on the discs.
- Some discs may not respond to this function.

Playing Repeatedly

THE HT-180 ALLOWS YOU TO PLAYBACK A SPECIFIC TITLE, CHAPTER, TRACK, OR SEGMENT REPEATEDLY. (TITLE REPEAT, CHAPTER/TRACK REPEAT, A-B REPEAT)

HOW TO REPEAT A TITLE, CHAPTER, OR TRACK

1. Select the title, chapter, or track you wish to repeat

2. Press the REPEAT button

The repeat mode changes each time you press the REPEAT button.

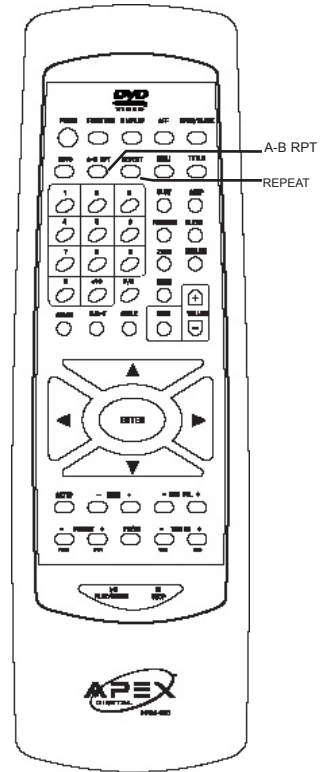
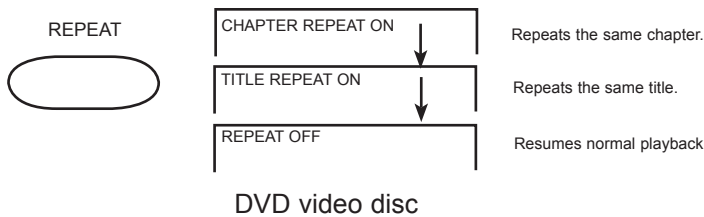

HOW TO REPEAT A SPECIFIC SEGMENT

1. Press the A-B RPT button at the beginning of the segment you wish to repeat playback (point A)



2. Press the A-B RPT button again at the end of the segment (point B)

The HT-180 will automatically return to point A and start to repeat playback of the selected segment (A-B).



3. Press the A-B RPT button to cancel the A-B repeat function

The HT-180 will resume to normal playback.



NOTICE

- Depending on the disc, you may experience a difference between point A and B the location where playback actually resumes.
- Be aware that some discs will not respond to the A-B repeat function.
- MP3 does not utilize this feature.

Zooming a Picture

ZOOMING A PICTURE

HT-180 ALLOWS YOU TO ZOOM INTO A PICTURE AS WELL AS SHIFT THE ZOOM POINT.
Press ZOOM button, then TV screen displays:

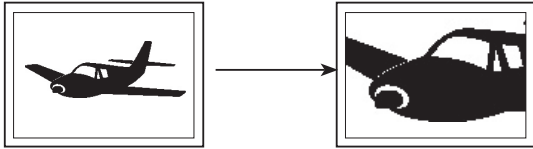

The unit magnifies in the center of the picture.

The picture will be magnified as follow:

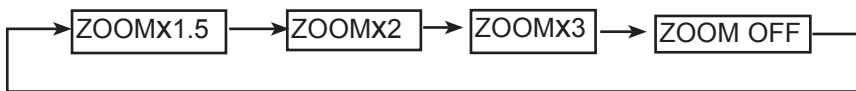

If you press  during zoom playback, the zoom point shifts.

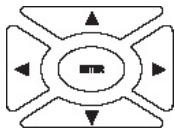

TO RESUME NORMAL PLAYBACK.
Press ZOOM repeatedly during zoom playback till the player switches to ZOOM OFF status.

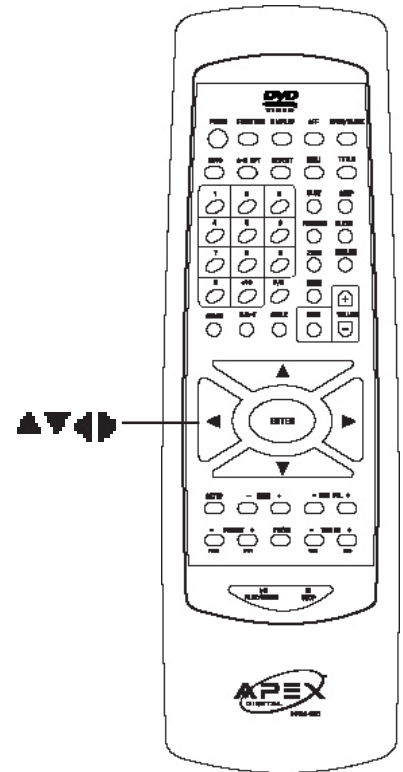

NOTICE

•Some discs may not respond to this function.

Selecting the Camera Angle/Selecting a Language

THE HT-180 ALLOWS YOU TO SELECT FROM SEVERAL DIFFERENT ANGLES AND LANGUAGES.

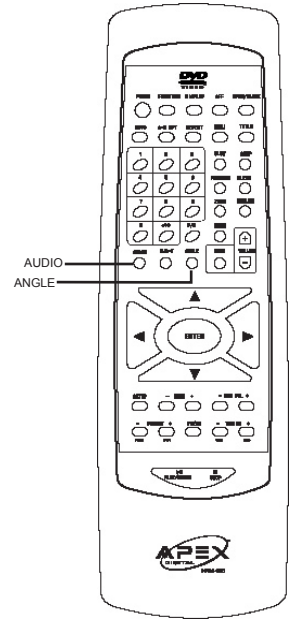
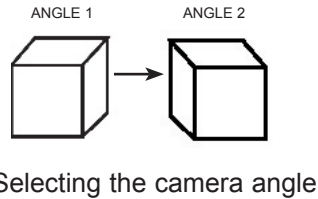

HOW TO CHANGE THE CAMERA ANGLE

If the DVD was recorded using the multiple angles feature, you have the option to change the camera angle of the scene you are watching.

Press the ANGLE button while playing back a scene recorded with multiple angles.

- Each time you press the ANGLE button, the angle will change.

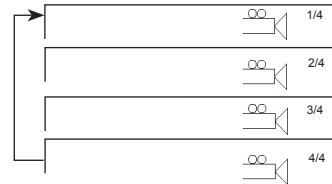

NOTICE

- The angle function will not work on DVDs that do not contain recorded multiple angles.
- During still playback, you are able to change the camera angle. However, when you resume to normal playback, the camera angle changes to the new settings.
- The angle icon indicator will illuminate while playing back a title that contains at least one scene recorded from multiple angles.

HOW TO SELECT A PLAYBACK AUDIO SETTING

The HT-180 allows you to select a preferred language and sound recording system from those included on the DVD video disc.

1. Press the AUDIO button during playback



Example

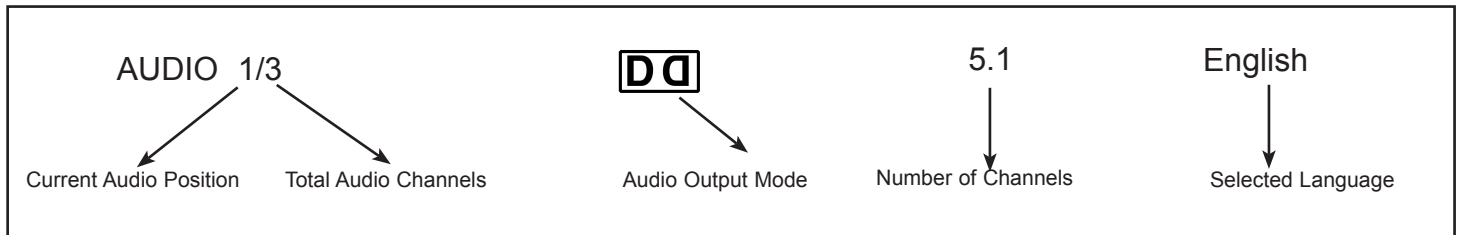

2. Continue pressing AUDIO until desired audio setting is reached.

Playing in a Favorite Order

YOU MAY COMBINE YOUR FAVORITE TITLES, CHAPTERS, OR TRACKS AND PLAY THEM BACK IN ANY ORDER. (PROGRAM PLAYBACK)

HOW TO SET TITLES, CHAPTERS, OR TRACKS IN A FAVORITE ORDER

The program playback function will automatically playback titles, chapters, or tracks in the order preprogrammed.

1. Insert a disc, during normal playback, press STOP twice, then press the PROGRAM button.



PROGRAM

At this time, the menu will appear.



PROGRAM P 00: T00 C000

Press / to switch between the title and the chapter.

2. Using the number button, input the number of the chapter/title you want, then press ENTER, as such to enter the next chapter/title in the order you want them programmed in.

Memory 1	PROGRAM ↓ P 01: T01 C004
Memory 2	PROGRAM ↓ P 02: T01 C009
Memory 3	PROGRAM ↓ P 03: T01 C001
Memory 4	PROGRAM ↓ P 04: T01 C003

To clear the numbers that have been programmed in just now, press CLEAR button.

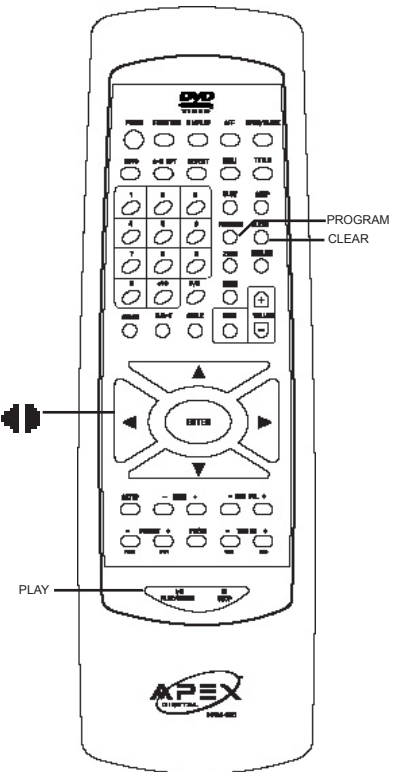

3. After entering all chapters/titles, press the ENTER button.



The unit starts program playback.

To CHANGE the programmed item:

Press the STOP button, then press PROGRAM twice.

To CANCEL the programmed item:

Press the STOP button, then press PROGRAM, at last press PLAY/PAUSE.

NOTICE

- When the HT-180 is turned off or discs are removed, the programmed item will be cancelled.
- Depending on the disc, the program playback may not function.

Selecting Subtitles

THE HT-180 ALLOWS YOU TO DISPLAY THE SUBTITLES FROM THOSE INCLUDED ON THE DISC, ON TO YOUR TV SCREEN.

HOW TO DISPLAY SUBTITLES

You have the option to select a preferred subtitle from those included on some DVD video disc.

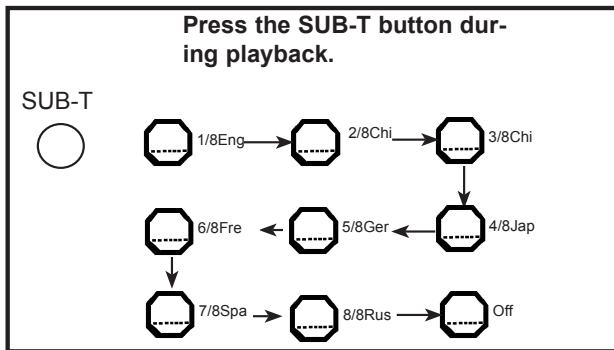

To TURN OFF the subtitles.

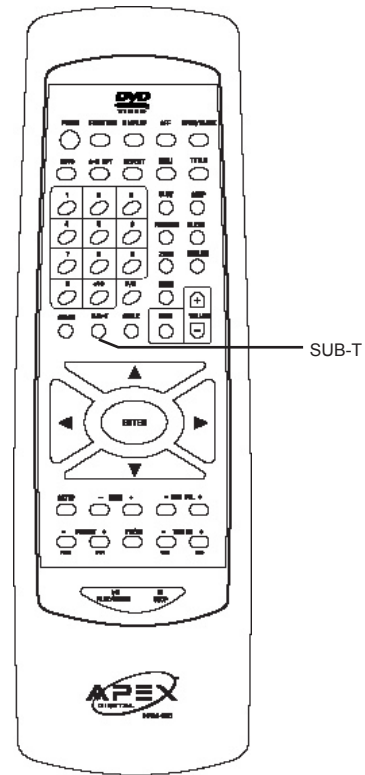
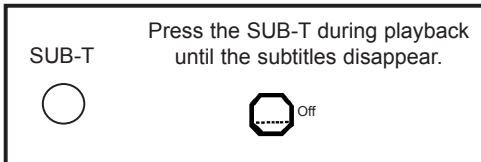

NOTICE

- Due to the nature of some DVDs, you may not be able to turn off the subtitles as they will appear on screen automatically.
- As you press the SUB-T button, the subtitles may not appear immediately during some scenes.

Karaoke

THIS UNIT ALLOWS YOU TO ENJOY KARAOKE WITH TWO MICROPHONES

HOW TO SETUP THE KARAOKE

Make sure that the Karaoke discs is a DVD Karaoke disc, This is the only compatible format that this unit will recognize.

1. Connect the microphone to **MIC 1** and **MIC 2**.
2. Set **"Karaoke Mode"** to **"On"** via the **Karaoke Setup** menu.



3. Adjust the MIC level and ECHO level.

- Press the **MIC VOL +** and **MIC VOL-** buttons to adjust the MIC level.
- Press the **ECHO +** and **ECHO -** buttons to adjust the ECHO level.

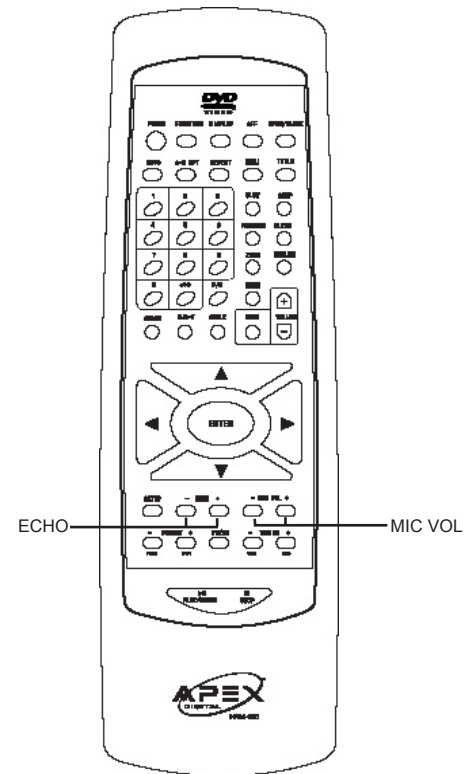

NOTICE

- While you are in the Karaoke mode and experience a sound, please try the following:
 - Keep the microphones away from any speakers.
 - Lower the sound level of the microphone.
 - Lower the sound level of the speaker.

MP3 Operation

WHAT IS MP3?

MP3 refers to a new format of music files available for playback over the internet. Because of the popularity to download music from MP3 websites onto ones home computer, APEX Digital is the first company to offer in a Digital Home Theater System , the ability to play back CD-R discs recorded with MP3 audio files.

OPERATION MODE

You can play back MP3 by different play mode, such as:

- “SINGLE”
- “REP-ONE”
- “FOLDER”
- “FOLDER REP”
- “DISC SCAN”
- “DISC”
- “DISC REP”
- “RANDOM”
- “SHUFFLE ON”
- “PROGRAM”

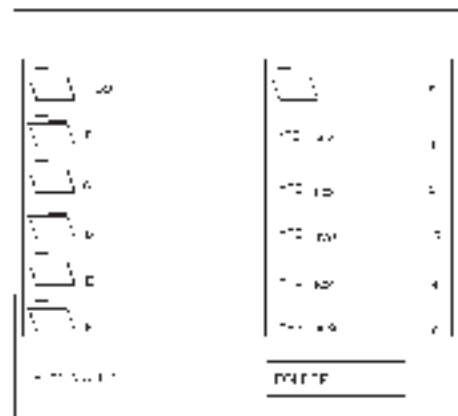

PLAYING AN MP3 FORMAT

- 1.You need a television to view the MP3 menu.Insert an MP3 CD,the unit will initialize the disc when the tray is closed and the directory (folder) will be shown in an MP3 MENU on screen.
- 2.Press the DIRECTION buttons to highlight the folders or songs you want, then press ENTER.
- 3.Select play mode:
Press ◀ or ▶ to select and highlight the PLAY MODE.
Then press ▲ or ▼ each way to select play mode options(repeat,random,etc.)
- 4.Press ◀ or ▶ to highlight the MP3 file, then press ENTER to play. Press SKIP ⏮ / ⏭ during playback to skip the tracks. If you need to return to the main directory(folder),press STOP.
- 5.You can press NUMBER buttons to select the item you want.

NOTICE

- The menu will refresh when you select a track using the ▲▼◀▶ buttons on the remote control.
- The left column is a list showing the name of the folder. The right column is a list showing the name of the song and the sub-folder.
- 📁 sign in front of a file name indicates that this is a folder, not an MP3 file.
- “MP3” sign in front of a file name indicates that this is an MP3 file.
- During MP3 playback, you cannot access to “PLAY MODE” folder or songs.
- For “RANDOM” playback, you are allowed playback randomly in a folder only.
- Depending on the disc, you may experience a difference.

Working With Your JPEG Files

What is a JPEG?

JPEG is short for the “Joint Photographic Experts Group”, a group of experts nominated to produce standards for continuous tone image coding.

The best known standard from JPEG is IS10918-1(ITU-T T.81), which is the first of a multi-part set of standards for still image compression. This allows you to create files (such as photographs, drawings, and most clip-art) that can be archived on a CD-R for viewing on this Home Theater System, computer, or the web.

How to Create a JPEG

Using your computer and a favorite computer software, you can create JPEG files capable of being played back on your TV Screen.

- 1) Open your computer software.
- 2) Locate the file menu and choose Open.
- 3) Depending on your software, you can:
 - Open an existing file from your hard drive
 - Open an existing file from a Disc (such as a 3.5” floppy disc)
 - Scan an image into your work area

Note: If you do not have an existing file, locate the file menu and choose New. This will open up a blank document which you can work image.

- 4) Once your existing file is open or new file is created, you can begin making modifications to your image.

Note: You can save any file in the JPEG format.

- 5) When modifications are complete, locate your file menu and choose Save or Save as.

Note: Other saving options might be Export, Export to the Web, or Save a copy As. Refer to your computer software’s help menu or manual.



- 6) After your file name and file type are chosen, click on the Save or Ok button to save you file as a JPEG.

Note: Most computer software automatically defaults to adding the .(dot) extension to the end of each file name. It is often best if you add the .jpg extension after each file name to insure universal readability.

- 7) To view your JPEG files on your TV screen, burn all your files on a CD-R disc using your computer software.

Note: Please refer to the details of the information.

Playing Your JPEG Files

1. When a JPEG disc is loaded into the player, a menu will appear on screen, From the Play Mode shown on the menu, select the “FOLDER” option using your direction keys.
2. You can select previous or next group using SKIP  /  buttons.
3. Thirteen slideshow “transition” modes are provided. You can press the RESUME button to select the preferred mode.

Working With Your JPEG Files

Normal Slide Show Presentation

Thirteen slideshow transition modes are provided. Use RESUME button to select the mode you want:

Normal Slide Show Presentation

Mode NONE: no special transition effect

Mode 1: wipe from top to bottom

Mode 2: wipe from bottom to top

Mode 3: wipe from top / bottom to center

Mode 4: wipe from center to top/bottom

Mode 5: vertical blinds

Mode 6: wipe from left to right

Mode 7: wipe from right to left

Mode 8: wipe from left/right to center

Mode 9: wipe from center to left/right

Mode 10: wipe from edge to center

Mode 11: horizontal blinds

Mode RAND: random

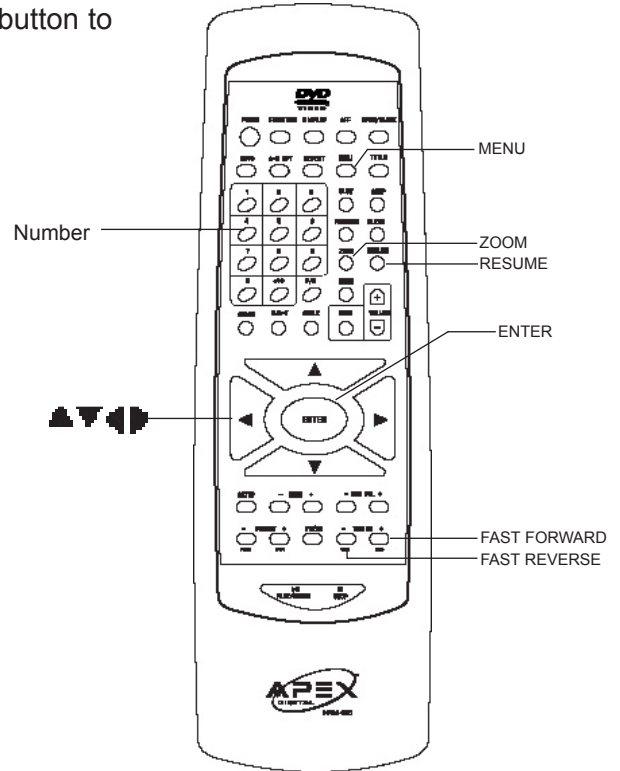

Image Rotation

There are four modes to rotate a picture: Invert, Mirror, Left, and Right. These operations are allowed only when a picture is being displayed normally, and will be cancelled automatically when a new picture is displayed. The DIRECTION buttons are used to select the different rotation modes:

Up: Invert/Normal Down: Mirror/Normal

Left: Turn left Right: Turn right

Zoom

1. This feature allows you to view a picture at 25%-200% in several increments. Press the ZOOM button.

An on screen message ("Zoom On") will verify your selection.

▶▶: Zoom In ◀◀: Zoom Out

2. Press the DIRECTION buttons to move the picture in any direction.

3. With Zoom Off, the picture is scaled to fit most of your TV screen.

Playing Back Your Kodak Picture CD

Normal

When a Kodak Picture CD is inserted, an automated slide show is launched. Each picture in the current directory will be displayed consecutively in slide-show fashion and will be scaled to fit most of the TV screen.

Thirteen slideshow transition modes are provided. Use RESUME button to select the mode you want:

Mode NONE: no special transition effect

Mode 1: wipe from top to bottom

Mode 2: wipe from bottom to top

Mode 3: wipe from top/bottom to center

Mode 4: wipe from center to top/bottom

Mode 5: vertical blinds

Mode 6: wipe from left to right

Mode 7: wipe from right to left

Mode 8: wipe from left/right to center

Mode 9: wipe from center to left/right

Mode 10: wipe from edge to center

Mode 11: horizontal blinds

Mode RAND: random

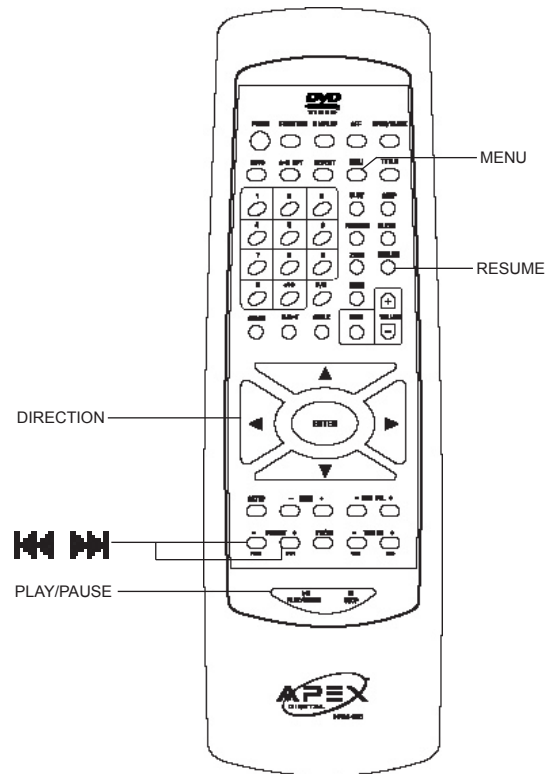

To Select PICTURE CD:

To display an image indefinitely, press the PLAY/PAUSE button;

To view the Next or Previous picture, press the SKIP  /  buttons.

Image Rotation



There are four modes to transformation: "Invert", "Mirror", "Left", and "Right". These operations will be cancelled automatically when a new picture is displayed.

The DIRECTION buttons are used to select the different transformation modes:

Up: Invert/Normal Down: Mirror/Normal

Left: Turn left Right: Turn right

Menu

The MENU key is used to display thumbnail pictures from the stop position. The SKIP  /  buttons can be used to display the NEXT and PREVIOUS 12 pictures in the current directory.

Using the On-Screen Display

THE HT-180 ALLOWS YOU TO VIEW THE OPERATIONAL STATUS AND DISC INFORMATION ON TO YOUR TV SCREEN.

CHECKING THE OPERATIONAL STATUS

Press DISPLAY during playback.

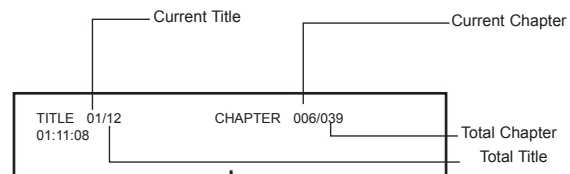
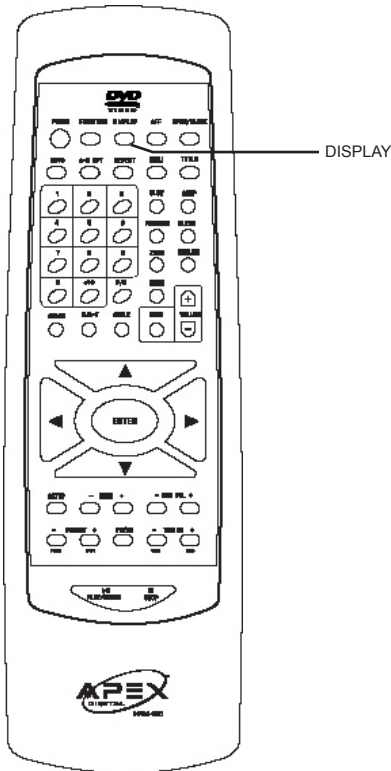

TO TURN OFF THE ON-SCREEN DISPLAY

Press DISPLAY repeatedly till the On-Screen display disappears.

DISPLAY



Setting the Parental Lock

YOU CAN USE THE PARENTAL LOCK FUNCTION ONLY WITH DVDS EQUIPPED WITH THE PARENTAL LOCK FEATURE.

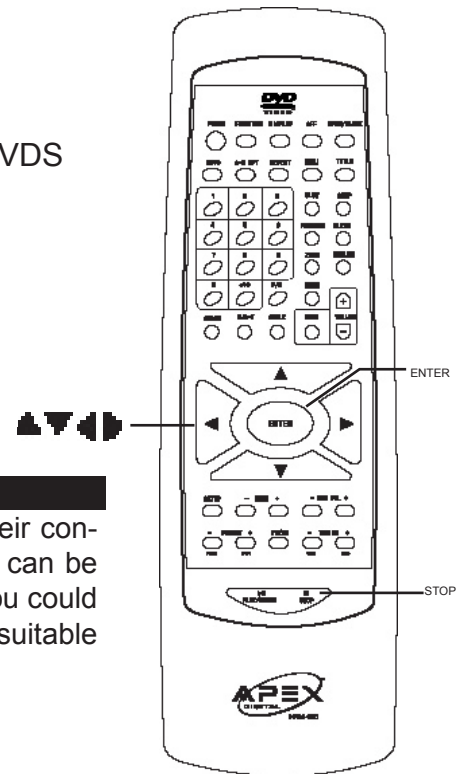

SETTING THE PARENTAL LOCK

DVDs equipped with the parental lock features are rated according to their content. The contents allowed by a parental lock level and the way a DVD can be controlled may vary from disc to disc. For example, if the disc allowed, you could edit out violent scenes unsuitable for children and replace them with more suitable scenes, or lock out playback of the disc altogether.

1. Press STOP during playback

Press STOP twice.



2. Press SETUP

The Setup Menu appears on the TV screen.

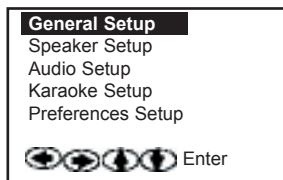

3. Select Preferences Setup, press ENTER

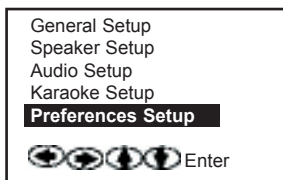

4. Select PARENTAL, press ENTER.

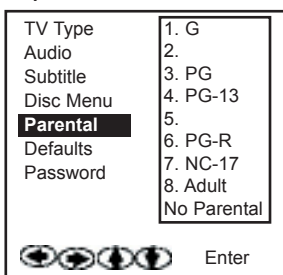

5. Select ratings, press ENTER

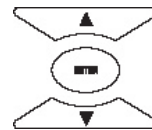

6. Enter your password then press ENTER

The pre-set password is **3308**



7. Press SETUP to exit setup, press PLAY to start.



TO CHANGE YOUR PASSWORD:



1. In stop mode, press SETUP button.
2. Scroll down to Preferences Setup. Press ENTER.
3. Scroll down to Password field and press ENTER.
4. Enter default Password(3308)or existing password.
5. Enter new password.
6. Confirm new password.

Customizing the Function Settings

THE HT-180 ALLOWS YOU TO CUSTOMIZE THE PERFORMANCE TO YOUR PERSONAL PREFERENCE.

1. Press the SETUP button, setup menu screen will display the main page.

2. Menu Selection

Press the   buttons and highlight the item you want.

Press the ENTER button.

3. Enter the sub-menu

Press the  button to enter the next sub-menu.

Press the   buttons and highlight the item you want.

Press the ENTER button.

Press the  button to go back to the previous menu.

4. Exit

Press the SETUP button during setting to exit the setup menu.

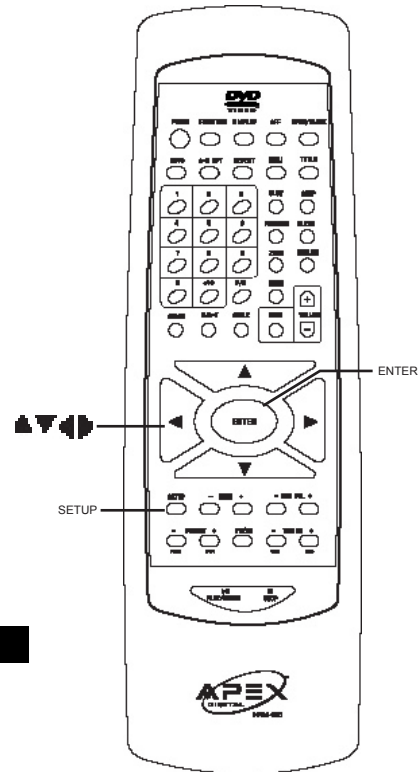

DISPLAYING THE SETUP MENU SCREEN

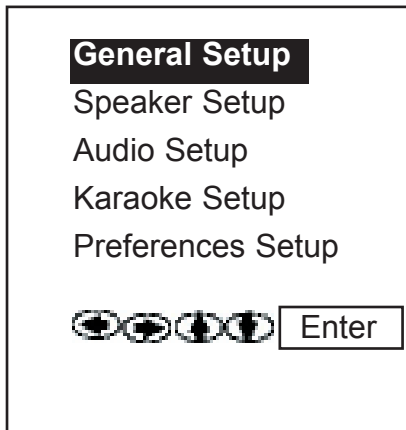

NOTICE:

- During setting, highlighted function will be expanded at right of the screen, please follow the instructions.
- During setup, the corresponding instructions will be expanded at the right of the screen.
- Some setup menus are related to the current state, when the menu turns to gray, the function may not be performed.

Customizing the Function Settings

DISPLAYING THE SETUP MENU SCREEN

The Setup menu screen asks you to select a setting category from General Setup, Speaker Setup, Audio Setup, Karaoke Setup and Preferences Setup. The selected category will provide you the setting details on-screen.

1. Press SETUP.

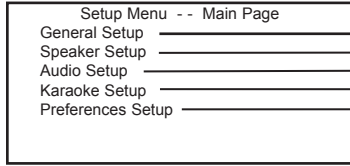

2. Press to select category (highlight), then press ENTER.

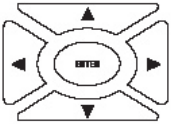

ENTER

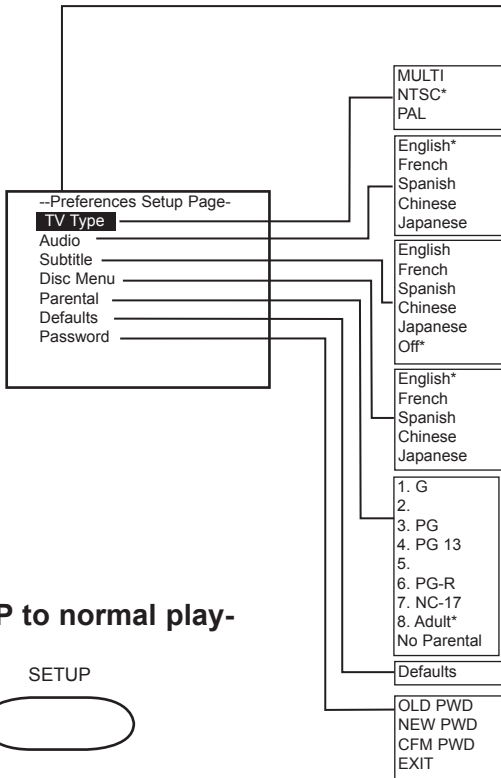

3. Press SETUP to normal play-back.

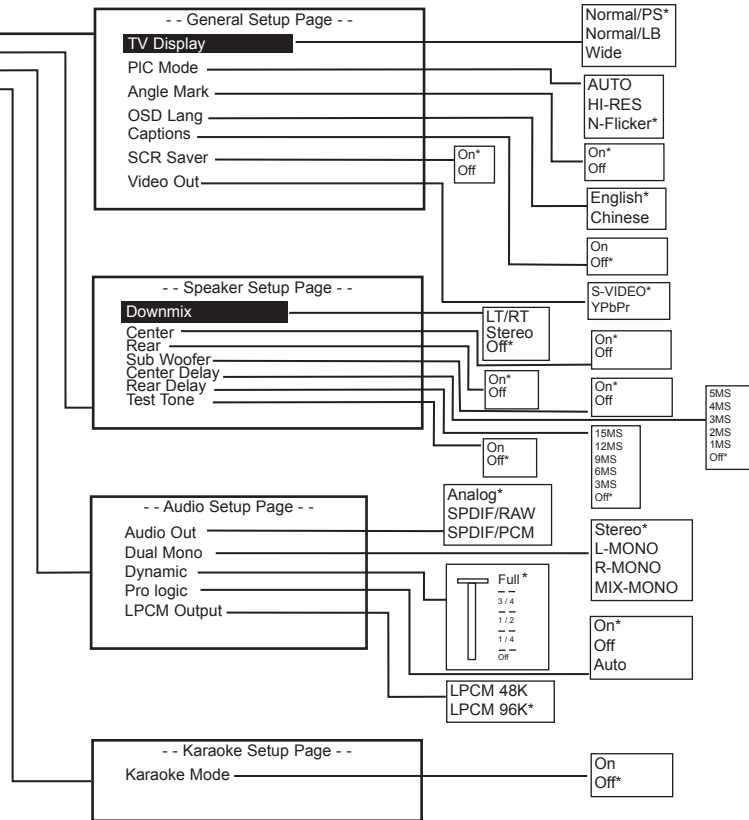

- Highlighted function will be expanded at right of the screen.
 - The Setup Menu screen disappears if you press the SETUP button while it is displayed.
 - Functions and menu may change without notice.
 - * Factory defaults
- You must press STOP to set up Preferences Setup.

Customizing the Function Settings

AM/FM Tuner Settings

1. Connect the supplied FM & AM Antennas.
2. To access the radio tuner press FUNCTION button. (Each press will access in order: DVD → Tuner → Analog In → DVD)
3. To change FM or AM band, press FM/AM button on remote control while in Tuner Mode.
4. To enter a station frequency directly, use number button.

Example: 94.7MHz-press 947(in FM mode), 1220KHz-press 1220(in AM mode), then press ENTER. If unwanted, press CLEAR button.

Storing Channels in Memory

Read thoroughly before attempting to store any radio stations. HT-180 stores 40 FM and 20 AM stations.

1. Press GOTO from the remote control. The tuner will automatically search and store all local stations with good signal strength.
2. Press TUNING+ or TUNING- button to scan back or forward to a desired radio station with good signal strength. To manual scan in increments or decreases press the TUNING + or TUNING - on the remote control for 1-2 seconds.
3. Press PRESET + or PRESET - to select stored frequencies in sequential order.
4. To number your stored stations, press SETUP, input the station number, then press SETUP again.

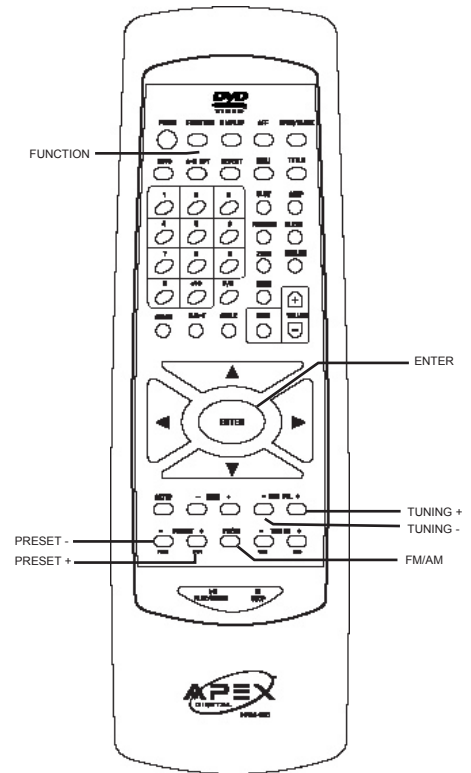

NOTICE

The default setting status of the HT-180 is DVD playback.

AFF Function

WHAT IS AFF?

AFF stands for APEX Full-screen Function. It allows you to fill the television screen viewing area when using a widescreen formatted DVD. Press the AFF button on your remote control, this will eliminate black bars on the top & bottom of the TV screen when viewing movies with an aspect ratio of 1.85:1 and minimize (but not eliminate) black bars on movies with a wider aspect ratio (2.35:1).

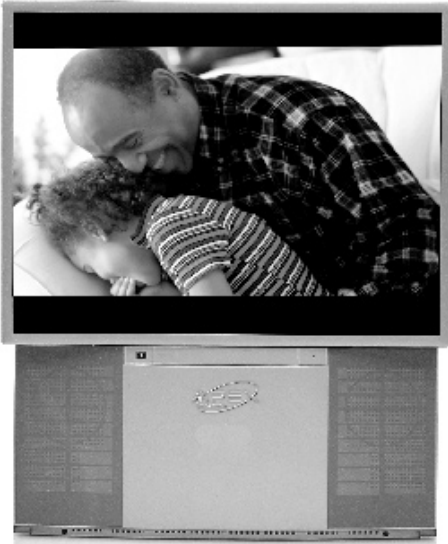

Before AFF

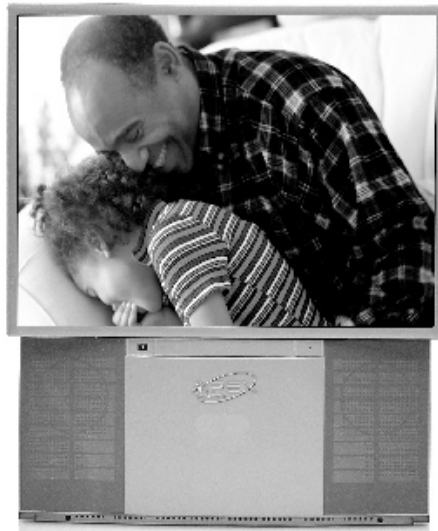

After AFF

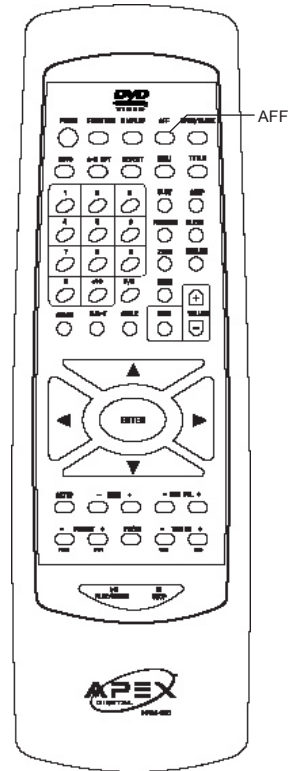

NOTE

AFF will not function in stop mode.

Memo On Output Sounds

DISCS AND OUTPUT SOUNDS

Sound recording system	DVD Video Discs											CD		MP3 CD	
	Dolby Digital			MPEG 2			Linear PCM					PCM44.1kHz		MP3	
	SPDIF /RAW	SPDIF /PCM	ANA-LOG	SPDIF /RAW	SPDIF /PCM	ANA-LOG	48kHz		96kHz			SPDIF /RAW SPDIF /PCM	ANA-LOG	SPDIF /RAW SPDIF /PCM	ANA-LOG
ANALOG AUDIO OUT jacks							—	—	o	—	—				
DIGITAL AUDIO OUT jack	Dolby Digital bitstream	PCM (48kHz)	—	MPEG 2 bitstream	PCM (48kHz)	—	PCM (48kHz)	—	PCM (48kHz)	—	—	PCM (44.1kHz)	—	PCM (44.1kHz)	—

MPEG 1 AUDIO LAYER 3 DISC (MP3)

MP3 Audio Disc Play Back Capable

MP3 audio disc can be played back by operating the unit in the same way as the audio CD.

Specifications

HT-180/OUTPUTS/SUPPLIED ACCESSORIES

HT- 180

Power supply	120V AC 60 Hz
Power consumption	98W
Mass	4.2 kg
External dimensions	355mm x 60mm x 345 mm (W/H/D)
TV Signal system	MULTI/NTSC/PAL
Laser	Semiconductor laser, wavelength 650 nm

SUPPLIED ACCESSORIES

RCA cable (yellow, red, and white)	1
Remote control	1
Batteries (AAA)	2
Owner's manual	1
AM loop antenna	1
FM wire antenna	1
Speakers	5
Woofers	1
Speaker cords	6

FM tuner section

System	PLL quartz-locked digital synthesizer system
Tuning range	87.5-108.00 MHz (100 kHz step)
Antenna	FM wire antenna
Antenna terminals	75 ohms, unbalanced
Intermediate frequency	10.7MHz

AM tuner section

System	Tuner section: PLL quartz-locked digital synthesizer system
Tuning range	530-1710 kHz (10 kHz interval)
Antenna	Loop antenna

Video section

Input	Video:1 Vp-p (75 ohms)
Outputs	Video:1 Vp-p (75 ohms)
	S-Video: Y:1 Vp-p (75 ohms)
	C: PAL 0.3 Vp-p (75 ohms)
	NTSC 0.286 Vp-p (75 ohms)

Speakers

Rated impedance	4 ohms
Dimensions (approx.)	102mmx 97mm x105mm
Mass (approx.)	0.57 kg

Subwoofer

Rated impedance	4 ohms
Dimensions (approx.)	350mmx160mmx350mm
Mass (approx.)	5.41 kg

Trouble Shooting Guide

Check the following guide for a possible correction to a problem before contacting customer service. Check FAQ at our website: www.apexdigitalinc.com.

SYMPTOMS AND CORRECTION

Symptom	Correction
No power	<ul style="list-style-type: none"> • Connect the power plug into the wall outlet securely.
No picture	<ul style="list-style-type: none"> • Verify the connection from the DVD video output to the TV video input. Then switch TV to appropriate mode (video 1). • Connect the video cable into the jacks securely. Refer to your television owner's manual.
No sound	<ul style="list-style-type: none"> • Connect the audio cables into the jacks securely. • Verify the connection from the DVD audio output to the TV or receiver audio input. Then switch to the appropriate source on the receiver. Refer to your audio amplifier owner's manual.
Rolling b/w picture	<ul style="list-style-type: none"> • From the Setup Menu select "TV Type". • Adjust the vertical hold on your TV.
Black & White picture	<ul style="list-style-type: none"> • Damaged S-Video connector (bent pin).
The playback picture has occasional distortion	<ul style="list-style-type: none"> • A small amount of picture distortion may appear because of a poor quality video/sound transfer to disc. This is especially true of some discs manufactured between 1997-1998.. • Scratched disc.
Brightness is unstable or noises are produced on playback pictures	<ul style="list-style-type: none"> • Connect the HT-180 directly through the TV and not through any other source. What you're viewing is the effect of the copy protection circuitry required on all HT-180s. • If you don't have a video input on your TV, you must purchase an RF adapter from your dealer.
The HT-180 does not start playback	<ul style="list-style-type: none"> • Place the disc with the graphics side up. • Place the disc on the disc tray correctly inside the guide. • Make sure the disc is free from scratches & fingerprints. • Press the SETUP button to turn off the menu screen. • Cancel the parental lock function or change the parental lock level. • Turn the power off then disconnect the power plug and reinsert it back into the wall outlet. Retry again. • Use region 1 discs only.
MP3 won't read disc or it skips	<ul style="list-style-type: none"> • Reburn disc as the software edition used may not be compatible with the player. Check web site for instruction. • Check web site for instruction on availability of a firmware upgrade. • Use new editions of software such as Voyetra Audiostation 4, Adaptec's "Easy CD Creator" or NTL or Roxio's Toast Titanium. • Make sure MP3 file are not encoded with a variable bit rate such as provided by Real Networks.
The remote control does not work properly	<ul style="list-style-type: none"> • Replace the batteries with new ones. • Operate the remote control within about 7m.

Limited Warranty



90 DAYS LABOR ONE YEAR REPLACEMENT OF PARTS

WHO IS COVERED?

Proof of purchase is required to receive warranty service such as the original sales receipt showing original date of purchase from an authorized APEX Digital, Inc. dealer in N. America. Keep your original box and packaging in case your unit needs to be shipped to us. You will need to prepay shipping and APEX will pay the cost of shipping the unit back to you.

WHAT IS COVERED?

Warranty repair from the original date of purchase: One (1) year replacement of parts; 90 days limited labor warranty coverage.

If you don't have proof of purchase, your unit will be considered out-of-warranty & will be charged at a flat labor rate.

WHAT IS EXCLUDED?

Your warranty does not cover:

- Labor charges for installation or setup of the product, adjustment of customer controls on the product, and installation or repair of antenna systems outside of the product.
- Product repair and/or part replacement because of misuse, accident, unauthorized repair or other cause not within the control of APEX Digital, Inc.
- A product that requires modification or adaptation to enable it to operate in any country other than the country for which it was designed, manufactured, approved and/or authorized, or repair of products damaged by these modifications.
- Incidental or consequential damages resulting from the product. (Some states do not allow the incidental or consequential damages, so the above exclusion may not apply to you. This includes, but is not limited to, pre-recorded material, whether copyrighted or not.)

BEFORE REQUESTING SERVICE:

Check your owner's manual under "Troubleshooting Guide" and visit our website www.apexdigitalinc.com for the latest updates under FAQ.

ORDERING ACCESSORIES:

You may purchase a remote control (\$20 U.S. or \$35 in Canada), owners manual (\$7), and/ or firmware upgrade, if applicable to your player (\$10). Specify model number, name & address with a cashiers check made out to APEX Digital.

MODEL # _____ **SERIAL #** _____

WHERE IS SERVICE AVAILABLE?

Please contact
customer service: APEX DIGITAL, INC.
2919 E. Philadelphia St., Ontario, CA 91761
(909) 930-1239 Monday-Friday 8:30am-5:00pm (California)
email: customerservice@apexdigitalinc.com

This warranty gives you specific legal rights. You may have other rights which vary from state/province to state/province.